

Angle Position Sensors

AN8 Sensors

Programmable, non-contact magnetic position sensors capable of continuous rotation



Description

The AN8 Series sensors are non-contact, intrinsically linear angle position sensors. The sensors operate through the use of Hall Effect technology with magnetic fields generated by permanent magnets. They provide a linear change in voltage output (ratiometric to the input voltage) corresponding to an angular rotation of the input shaft.

Features

- Angular position sensor with high tolerance for misalignment
- Non-contact angular position sensing and full 360° rotation
- Custom programming available for: angle range, slope, PWM output, custom magnets – contact factory
- No mechanical interface means no parts to wear out or jam
- Available with Delphi connector or 12" (305 mm) wire leads
- RoHS compliant
- IP67
- Maximum air gap of 5.5 mm (0.22")*

Typical Applications

- Implement (fork lift, agricultural trailer hitch, etc.) position sensing
- Steer, throttle by wire
- Gear selection
- Zero-contact encoder alternative
- Replacement for smart bearings
- Outboard trim sensing

Environmental Specifications

Vibration	6g sinusoidal, 8 g RMS axial; 40Hz – 2 kHz all 3 axes
Operating Temperature	-40 °C to 125 °C (-40 °F to 257 °F) with Delphi connectors, -40 °C to 150 °C (-40 °F to 302 °F) with wire leads
Storage Temperature	-40 °C to 150 °C (-40 °F to 302 °F)
Ingress Protection	IP67

Electrical Specifications

Input Voltage	5.0 VDC ± 10%
Output Voltage	10% to 90% of input (see graph for voltage vs. rotation angle characteristics)
Input Current	14 mA typ., 16 mA max.
Output Current	-8 mA to 8 mA
Output Accuracy	±3.5%
Output Linearity	±3.5%
Maximum Overvoltage	16 VDC
Absolute Max. Output Current	±30 mA
Output Type	Analog (PWM available)

Mechanical Specifications

Housing Material	Glass Reinforced Plastic
Mechanical Travel	0° to 360° (continuous)
Mating Connector	Delphi Metri-pak 150.2 12162185; Terminal 1214075 / 2047680
Maximum Air Gap*	5.5 mm (0.22")
*with AS500106 magnet carrier	
Maximum Center-To-Center Offset	2 mm radial (magnet to center)

<https://switches-sensors.zf.com/>

Products

Part Number (Sensor)	Sensor (incl. AS500106 magnet)	Sensing Range	Wires	Connectors	Terminals
AN820001	CU103601	180°	N/A	Packard Metri-pack	1214075 / 2047680
AN820002	CU103602	360°	N/A	Packard Metri-pack	1214075 / 2047680
AN820003*	CU103603	45°	N/A	Packard Metri-pack	1214075 / 2047680
AN820031	-----	180°	18 AWG x 305 mm (12")	N/A	N/A
AN820032	-----	360°	18 AWG x 305 mm (12")	N/A	N/A
AN820033*	-----	45°	18 AWG x 305 mm (12")	N/A	N/A

*Not commonly stocked

Sensor Output

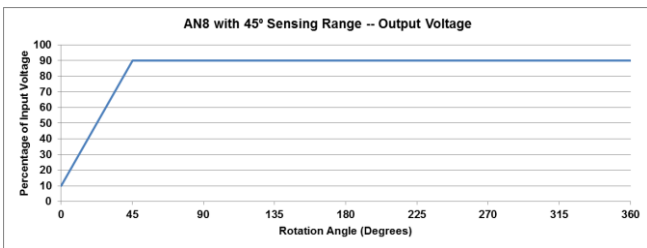
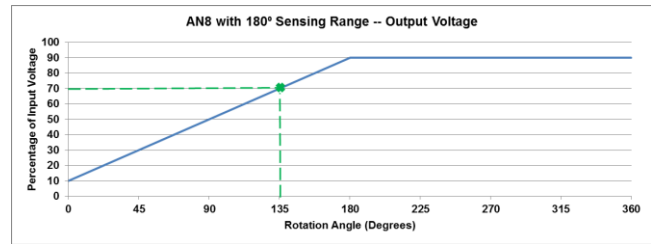
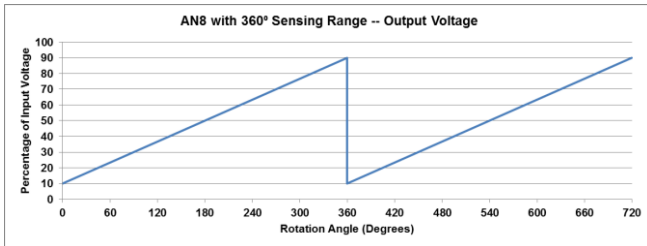

These charts show the output voltage as a percentage of the input voltage for a given angle of rotation. Example: 180° sensing range, magnet rotated 135°, output voltage will be 70% of input voltage (see dashed lines in graph above).

Dimensions mm (inches)

AN8 WITH MAGNET SHOWN WITH CONNECTOR

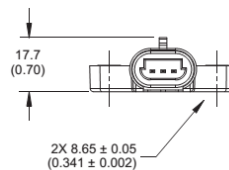
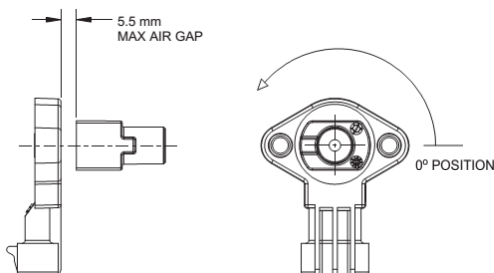

CONNECTOR - ELECTRICAL PINOUT

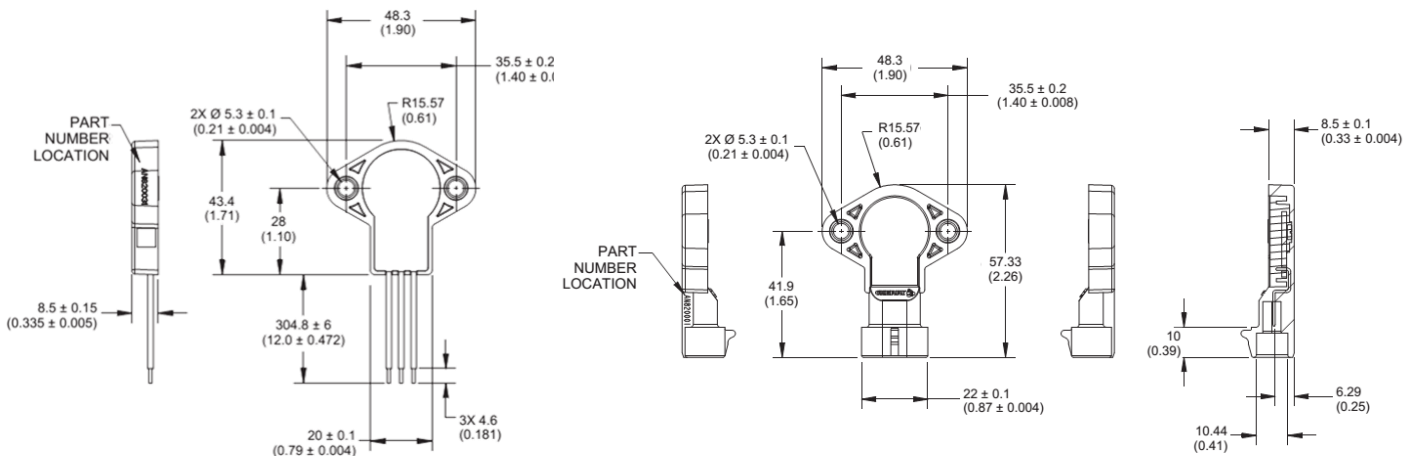
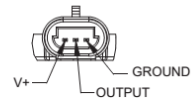

<https://switches-sensors.zf.com/>