

Angle Position Sensors

AN9 Sensors

Thin, programmable, non-contact magnetic position sensors capable of continuous rotation with dual outputs



Description

The AN9 Series sensors are non-contact, intrinsically linear angle position sensors with two independent outputs. The sensors operate through the use of Hall Effect technology with magnetic fields generated by permanent magnets. They provide a linear change in voltage output (ratiometric to the input voltage) corresponding to an angular rotation of the input shaft.

Features

- Angular position sensor with high tolerance for misalignment
- Non-contact angular position sensing and full 360° rotation
- Dual independent (fully redundant) outputs assure high reliability
- Custom programming available for: angle range, slope, PWM output, custom magnets – contact factory
- No mechanical interface means no parts to wear out or jam
- Comes with 18 AWG 305 mm (12") wire leads
- RoHS Compliant
- IP68*
- Maximum air gap of 5.5 mm (0.22")**

Typical Applications

- Implement (fork lift, agricultural trailer hitch, etc.) position sensing
- Steer, throttle by wire
- Gear selection
- Zero-contact encoder alternative
- Replacement for smart bearings
- Outboard trim sensing

Environmental Specifications

Vibration	15g sinusoidal, 9.26g RMS axial; 40 Hz – 2 kHz all 3 axes
Operating Temperature	-40 °C to 125 °C (-40 °F to 257 °F)
Storage Temperature	-40 °C to 150 °C (-40 °F to 302 °F)
Ingress Protection	IP68*

*submerged in 22±3 °C water for 1 hour at 2 m depth

Electrical Specifications

Input Voltage	5.0 VDC ± 10%
Output Voltage	10% to 90% of input (see graph for voltage vs. rotation angle characteristics)
Input Current	14 mA typ., 16 mA max.
Output Current	-8 mA to 8 mA
Output Accuracy	±2.5%
Output Linearity	±2.5%
Maximum Overvoltage	16 VDC
Absolute Max. Output Current	±30 mA
Output Type	Analog (PWM available)

Mechanical Specifications

Housing Material	Glass Reinforced Plastic
Mechanical Travel	0° to 360° (continuous)
Maximum Air Gap**	5.5 mm (0.22")
**with AS500106 magnet carrier	
Maximum Center-To Center Offset	2 mm radial (magnet to center)

Note: When used with AS500106 Magnet Carrier; user is responsible for determining characteristics when using other magnets.

www.switches-sensors.zf.com ZF Electronics Systems Pleasant Prairie, LLC ("ZF") acquired the rights to the CHERRY branded switches and sensors in 2008. Although ZF divested its interest in the CHERRY name in 2015, the switches and sensors remain unchanged and are now sold under the ZF brand.



Products

Part Number (Sensor)	Sensing Range	Wires
AN920031	180°	18 AWG x 305 mm (12")
AN920032	360°	18 AWG x 305 mm (12")
AN920035*	45°	18 AWG x 305 mm (12")
AN920036	90°	18 AWG x 305 mm (12")

*Not commonly stocked

Sensor Output

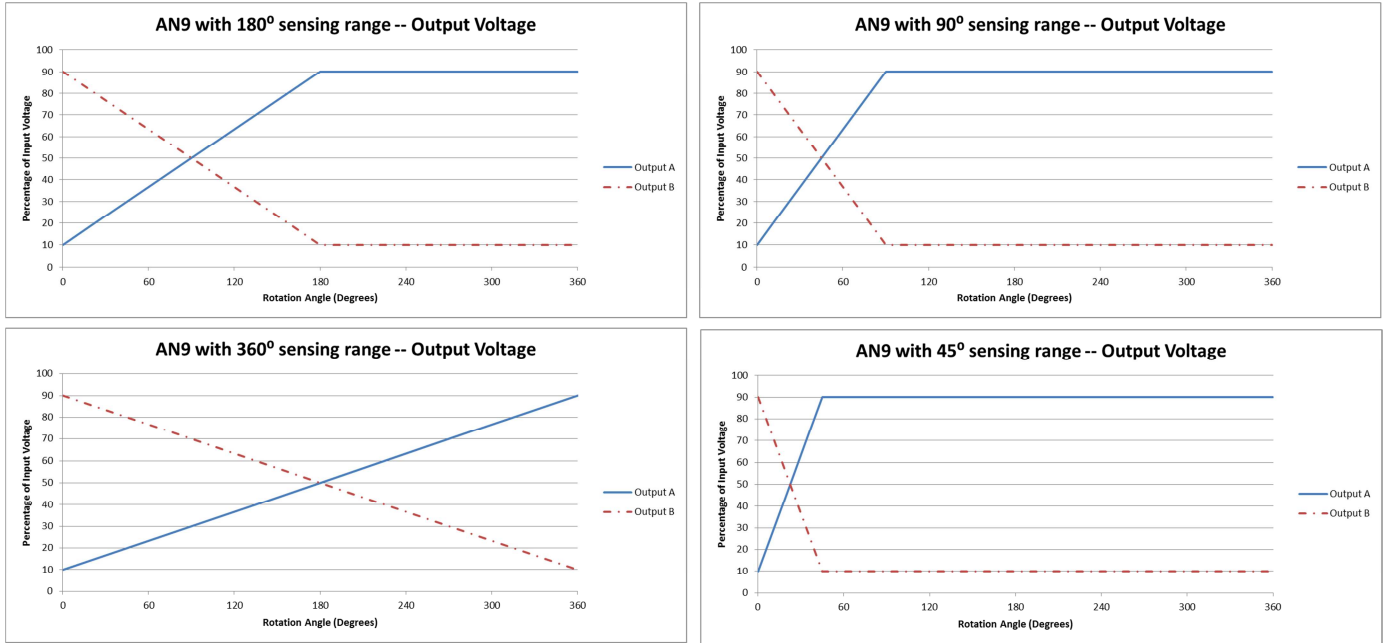

Dimensions mm (inches)

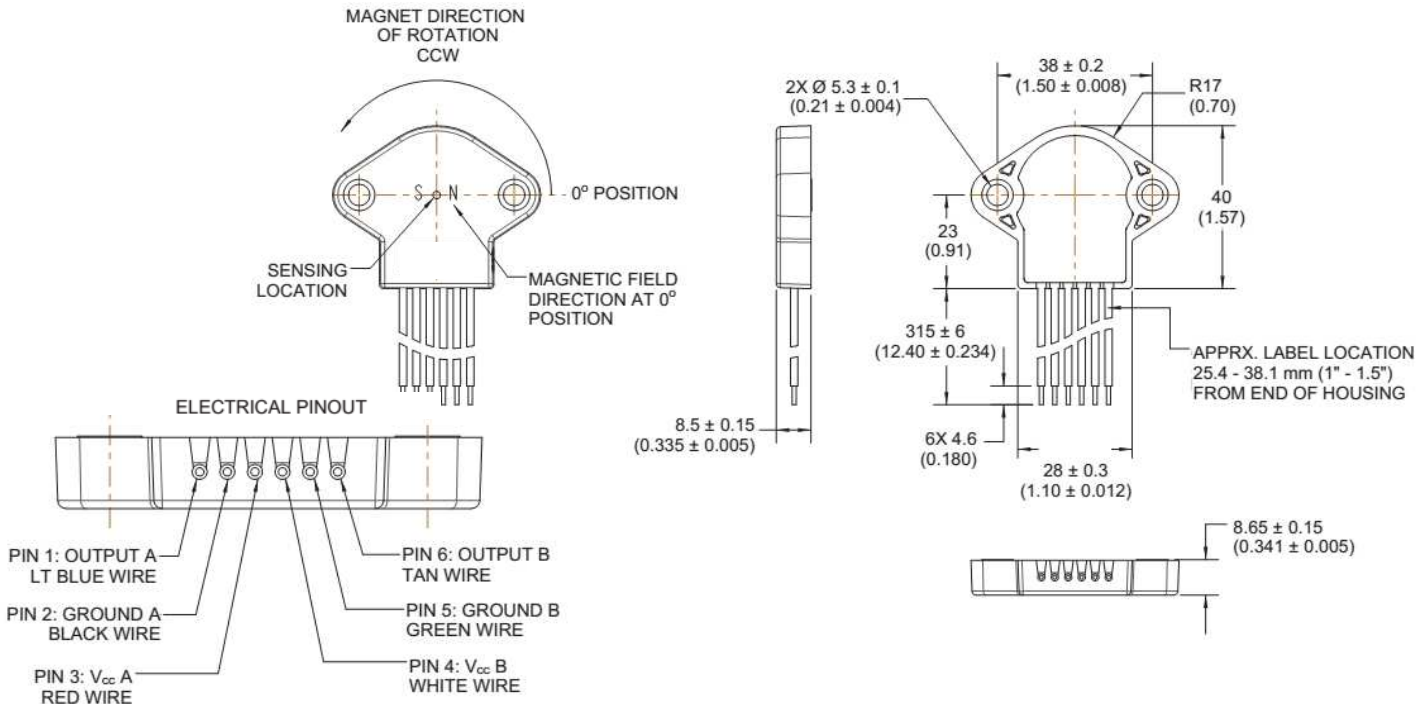

www.switches-sensors.zf.com ZF Electronics Systems Pleasant Prairie, LLC ("ZF") acquired the rights to the CHERRY branded switches and sensors in 2008. Although ZF divested its interest in the CHERRY name in 2015, the switches and sensors remain unchanged and are now sold under the ZF brand.

