

Panel Mount Pushbutton



Single Pole

E6 F6 series

Features

- Choice of Momentary, Push-Pull (reset) and Cheat Interlock
- Long life coil spring snap action mechanism
- Agency approved extended life versions available
- Snap in mounting
- ENEC available on select models

Standard Parts

0E65-00A0 0E68-00A0 0E68-30A0 0E68-40A0 0E69-00A0 0E69-30A0 0E69-40A0
0F69-00A0 0F69-30A0 0F69-65A0 0F69-66A0

Notes:

Part numbers with a leading 0 and a trailing 0 are functionally no different than without a leading / trailing 0.

Electrical Specifications – Contact Ratings

Switch Series	According to EN61058-1		According to UL1054	
	Nominal Load	Operating Cycles	Nominal Load	Operating cycles
0E65	N/A	N/A	16 A, 125/250 VAC; 1/3 HP; 125/250 VAC	6,000 *
0E68	N/A	N/A	0.1 A 125 VAC	6,000 *
0F68	0.1(0.05) A, 125 VAC;	50,000		
0E69	N/A	N/A	10 A, 125/250 VAC; 1/3 HP, 125/250 VAC	6,000*
0F69	10(4)A, 250 VAC	50,000		

*Extended life UL versions available. Contact factory for more information. Special part number required.

Environmental and Mechanical Specifications

Operating force	285 – 708 grams
Temperature range	-40 °C to 85 °C
Protection class	IP40
Terminal dimensions	Up to 10 A: 4.8 mm x 0.5 mm or 4.8 mm x 0.8 mm; 16 A: 6.3 mm x 0.8 mm

Material Specifications

Case	Thermoplastic Polyester
Actuator button	Thermoplastic Acetal
Terminals	Brass (Common Ag plated)
Moving blade	Beryllium Copper
Spring	Stainless Steel
Contacts	Silver Alloy, Gold Alloy

<https://switches-sensors.zf.com/>

Page 1 of 2, Last update 2025-02-26, Specifications subject to change without notice. In case there are any deviations, the drawing details have priority.



Dimensions (mm) and terminal configurations

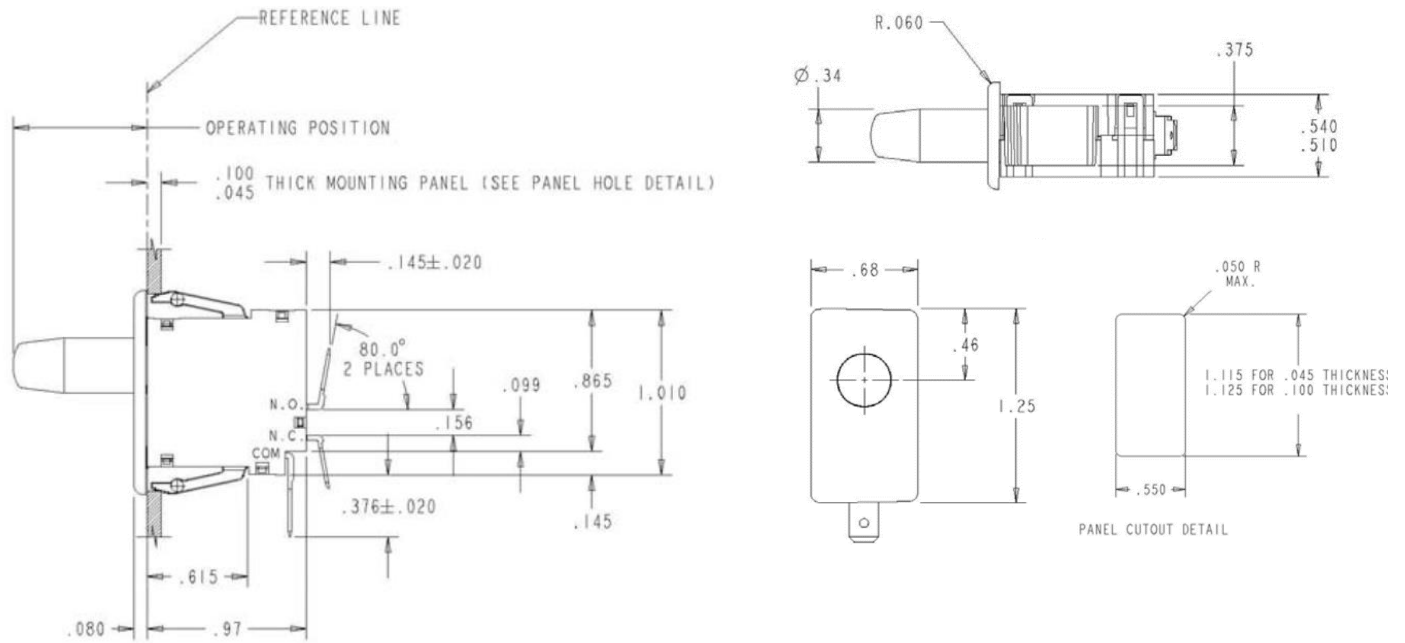

Button details

Actuator (function)

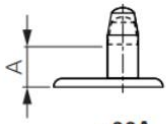

- 00A
- 66A

Basic momentary
(Makes contact while actuated)

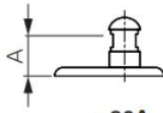

- 20A

Push-pull (Push:
makes contact, Pull:
reset position)

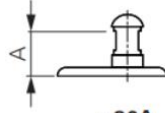

- 30A
- 65A

Momentary
(If pushed: normal
pushbutton function)

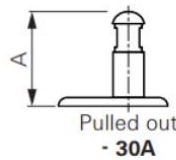

- 30A

Cheat interlock
(If pulled: permanent
contact function)

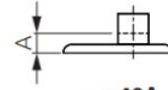

- 40A

Short button momentary
(Makes contact
while being actuated)

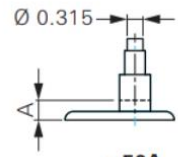

- 50A

Momentary – for auxiliary
button (Makes contact
while being actuated)