



ZF Group · Graf-Zeppelin-Straße 1 · 91275 Auerbach

**Electrified Powertrain Technology**  
Electronics

Department Portfolio Switches and Sensing Solution  
From  
Phone +49 9643 18-0  
E-mail Switches-sensors@zf.com  
Date 08.08.2023













## Product Change Notification (PCN)

### – product upgrade Ultraminiature Switch Series DH

<b>1. Product Type</b> Ultraminiature Switch Series DH			
<b>2. Affected Part Numbers – current versions beginning with</b> DH2			
<b>3. Description of Change/ Upgrade</b>			
Item	Current version	New upgrade version	Remarks
Outline dimension (L*W*H)	8.2 mm x 2.7 mm x 6.2 mm	8.4 mm x 2.7 mm x 6.95 mm	See P8. + P9. "pictures/ deviations"
Reference line to top surface of cover	4.45 mm	4.95 mm / 4.85 mm	
Emboss on cover top	0.15 mm	0.40 mm	
Actuator dimension	0.89 mm x 0.58 mm	1.00 mm x 0.90 mm	See technical specification
Ambient temperature	– 25°C to + 70°C	– 25°C to + 85°C	
Housing material	PPS (UL 94V-0)	PPA (UL 94V-0)	
Cover material	PBT (UL 94V-0)	PA (UL 94V-0)	
Auxiliary actuator material	PBT (UL 94V-0)	PA (UL 94V-0)	
Code of rating (3rd digit of PN)	2	G	
Code with auxiliary actuator	PA	LA	

Chairman of the Supervisory Board: Dr. Heinrich Hiesinger  
Board of Management: Dr. Holger Klein (CEO),  
Dr. Martin Fischer, Michael Frick, Sabine Jaskula, Dr. Peter Laier,  
Stephan von Schuckmann  
Headquarters: Friedrichshafen ·  
Trade register of the municipal court of Ulm HRB 630206

**ZF Group**  
**ZF Friedrichshafen AG**  
Graf-Zeppelin-Straße 1  
91275 Auerbach  
Germany  
Phone +49 9643 18-0  
Fax +49 9643 18-1262  
www.zf.com

<p><b>4. Effect on the product</b> - new upgrade versions beginning with part number DHG</p>						
<p><b>5. Quality Assurance Measures</b> ZF Friedrichshafen AG is certified according to ISO 9001:2015</p>						
<p><b>6. Scheduled date of introduction</b> Q3/ 2023</p>						
<p><b>7. Customer information</b> See conversion list for new part numbers See technical specification for further product information New orders shall be placed for the upgrade version only.</p>						
<p><b>8. Pictures</b></p> <table><thead><tr><th>Current version</th><th>Upgrade version</th></tr></thead><tbody><tr><td></td><td></td></tr><tr><td></td><td></td></tr></tbody></table>	Current version	Upgrade version				
Current version	Upgrade version					
						
						

## 9. Deviations

Current version

Upgrade version

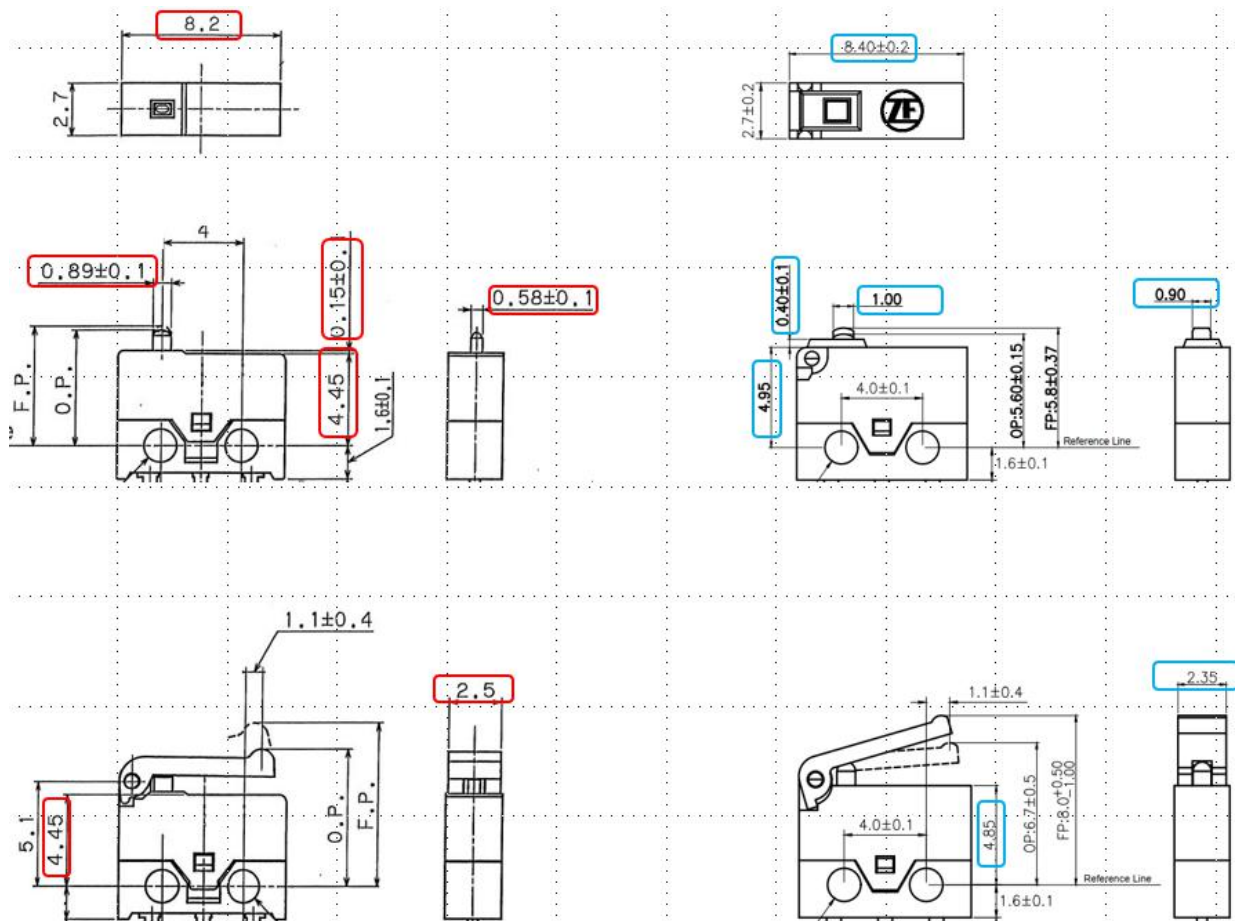

## 10. Appendix

- Conversion list new part numbers
- Technical specification TS-DH-00001
- Drawings

## Conversion list DH Upgrade

Current part number	New part number
DH2C-B1AA	DHGC-B1AA
DH2C-B1PA	DHGC-B1LA
DH2C-B2AA	DHGC-B5AA
DH2C-B2PA	DHGC-B5LA
DH2C-B3AA	DHGC-B4AA
DH2C-B3PA	DHGC-B4LA
DH2C-C4AA	DHGC-C4AA
DH2C-C4PA	DHGC-C4LA
DH2C-C5AA	DHGC-C5AA
DH2C-C5PA	DHGC-C5LA
DH2C-C6AA	DHGC-C6AA
DH2C-C6PA	DHGC-C6LA



# Technical Specification

## TS-DH-00001

00	2022, Nov 8	H. Qin	J. Wang
INDEX	DATE	NAME	SIGNATURE EMS



## Table of Contents

1. General Characteristics .....	3
1.1 Application.....	3
1.2 Operating Temperature Range.....	3
1.3 Operating Relative Humidity.....	3
1.4 Storage Temperature Range.....	3
1.5 Test Conditions.....	3
2. Appearance, Structure & Dimensions .....	3
2.1 Appearance.....	3
2.2 Structure & Dimensions .....	3
2.3 Markings .....	3
3.Type Reference Matrix.....	3
4. Initial Electrical Characteristics.....	4
4.1 Contact Resistance .....	4
4.2 Insulation Resistance.....	4
4.3 Dielectric Voltage.....	4
4.4 Bounce time.....	4
5. Initial mechanical Characteristics.....	4
5.1 Operating Force.....	4
5.2 Releasing Force.....	4
5.3 Free Position.....	4
5.4 Operation Position .....	4
6.Mechanical Characteristics .....	4
6.1 Terminal Strength.....	4
6.2 Vibration.....	4
6.3 Shock.....	4
6.4 Solderability.....	5
6.5 Solder Heat Resistance .....	5
7. Durability Characteristics .....	5
7.1 Mechanical Lifetime without Load .....	5
7.2 Electronics Lifetime .....	5
8. Weather Resistance Characteristics .....	6
8.1 Low temperature.....	6
8.2 High temperature.....	6
8.3 Heat and Humidity Resistance .....	6
8.4 Temperature Cycling .....	6
9. Remarks .....	6
10. Precautions for use .....	7
10.1 General .....	7
10.2 Soldering and assembly .....	7
10.3 Assembly structure and Mechanical design.....	7
10.4 Minimum using load .....	7
10.5 Operating Environment .....	7
10.6 Storage Conditions .....	8
10.7 Others .....	8
11. Appendix: Sketch of operating parameters .....	8



## 1. General Characteristics

1.1 Application: This specification is applied to the micro switch for general applications.

1.2 Operating Temperature Range: -25°C to +85°C

1.3 Operating Relative Humidity: ≤85% at +5°C to +40°C

1.4 Storage Temperature Range: -25°C to +40°C

1.5 Test Conditions - Unless otherwise specified, the atmospheric conditions for making measurements and tests are as following:

Ambient Temperature: 5-35°C

Air Pressure: 86-106Kpa (860-1060mbar)

Relative Humidity: 25-85%RH

## 2. Appearance, Structure & Dimensions:

2.1 Appearance: The switch shall have good appearance, no rust, crack or plating defects.

2.2 Structure & Dimensions: Refer to the product drawing.

2.3 Markings: Refer to the product drawing.

## 3. Type Reference Matrix:

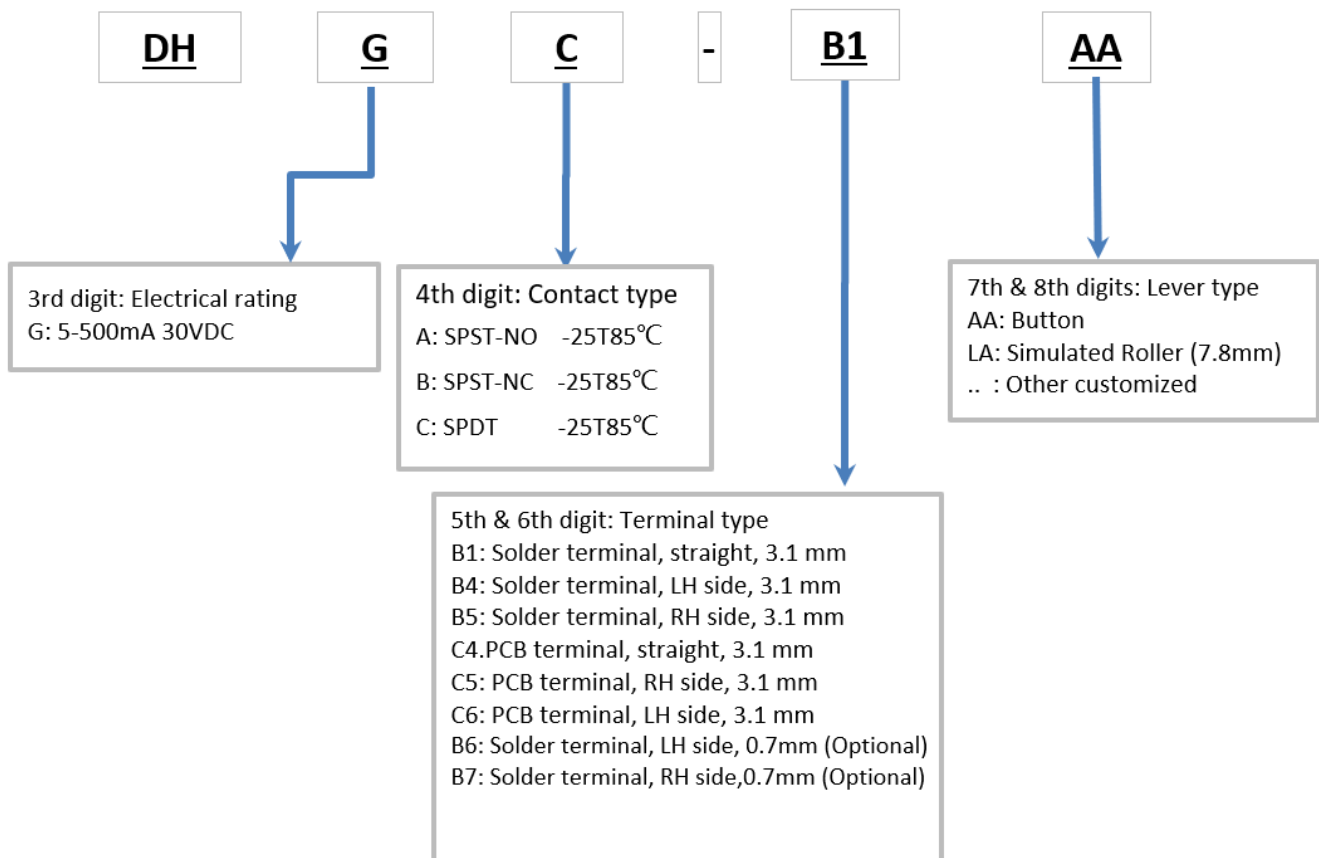

#### 4. Initial Electrical Characteristics:

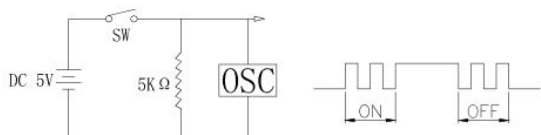
Item	Criteria	Test Method
4.1 Contact Resistance	50mΩ Max. as initial value	Shall be measured at 3VDC 0.01A by voltage drop method.
4.2 Insulation Resistance	100MΩ Min.	500V DC voltage is applied between each pair of terminals, and between the terminal and exposed non-current carrying metal parts for 60±5 sec.
4.3 Dielectric Voltage	No dielectric breakdown shall occur.	Between terminals: 500V AC shall be applied for 1 minute, Between terminals and grounded parts: 500V AC shall be applied for 1 minute.
4.4 Bounce time	ON:5 ms Max OFF:5 ms Max as initial value	 <p>Remark: Min testing voltage 3V.</p>

#### 5. Initial Mechanical Characteristics

Item	Criteria	Test Method
5.1 Operating Force	Refer to the product drawings.	A static load shall be applied to the tip of actuator in operating direction to change the component to operating position
5.2 Releasing Force		A static load shall be reduced to the tip of actuator in operating direction to change component from operating position to release Position.
5.3 Free/Rest Position		When the switch is free, the distance between the operation element end and the surface of PCB.
5.4 Operation position		When the switch switched on, the distance between the operation element end and the surface of PCB

#### 6. Mechanical Characteristics

Item	Criteria	Test Method
6.1 Actuator and Terminal Strength	After test: - Electrically and mechanically performances shall be satisfied.	A static load shall be gradually applied to objects to be tested for 5 sec. Each object can be tested once. Actuator: 4.9N min. Axial direction of terminals: 9.8N min. Other directions of terminals: 4.9N min.
6.2 Vibration Test	After test: - Electrically and mechanically performances shall be satisfied.	Switch shall be fixed to the testing machine under required mounting method, and be tested under following conditions: (1) Vibration frequency range = 10-55 Hz (2)Amplitude = 1.5mm (3) Sweep ratio: 10-55-10Hz Approx. 1 min. (4)Method of changing the sweep vibration frequency: Logarithmic or linear (5)Direction of vibration: Three perpendicular directions including actuating direction. (6) Duration: 2 hours per direction (6 hours in total)
6.3 Shock Test	After test: - Electrically and mechanically performances shall be satisfied.	Switch shall be tested under following conditions: (1) Mounting Method: Normal (2) Acceleration: $294 \text{ m/s}^2$ ( 30G) (3) Duration: <u>11ms</u> (4)Test Direction: 6 directions (5) Number of shocks: 3 times per direction(18 times in total)

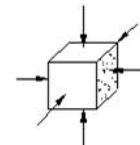



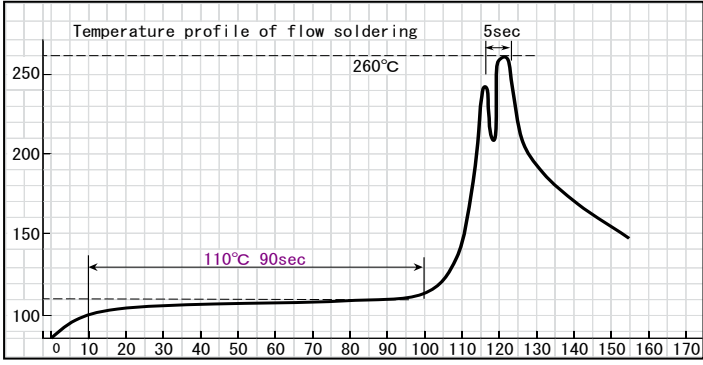

6.4	Solderability	More than 75% of immersed part shall be covered with solder. (Except for cutting Profile)	Switch shall be tested under following conditions: (1) Solder: Sn-3Ag-0.5Cu (2) Flux: Rosin Flux JIS K 5902 (3) Soldering Temperature: 255 ± 5°C (4) Immersing Time: 3 ± 0.5 sec.
6.5	Solder Heat Resistance	After test: - Electrically and mechanically performances shall be satisfied.	Switch shall be tested under the following conditions: (1)Soldering Temperature & Immersing Time(tin/lead-free): Wave soldering: 255± 5°C Max 5sec. Manual soldering: 350±10°C Max 5sec. (2)Solder: Sn-3.0 Ag-0.5 Cu tin/lead-free. (3)Flux: 25% Rosin, 75% methyl alcohol colorless transparent solution. (4)Immersing speed: 25(±6) mm/sec. (5)Immersion Depth: be 1~1.5mm apart from the assembly reference surface. (6)The product should go through wave soldering for 1 time under following condition.  

### 7. Durability Characteristics

X	Item	Criteria	Test Method
7.1	Mechanical Lifetime without Load	After test: - Contact resistance: 200mΩ Max - Insulation resistance: 10MΩMin. - Operating force range: ±30% of initial value	Operation shall be performed continuously at a rate of 30 cycles per minute without load for 50,000cycles.
7.2	Electronics Life Time	- Other electrical and mechanical performances shall be satisfied.	Continuously operating at 500mA/30VDC for 30,000 cycles, 100% over-travel, 10 cycles/minute, under room temperature.

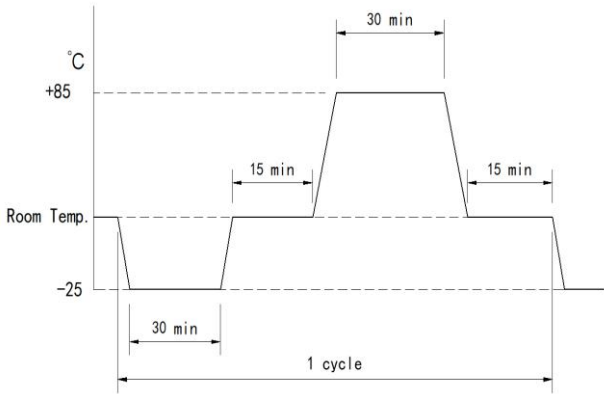

## 8. Weather Resistance Characteristics

Item	Criteria	Test Method
8.1 Low temperature	After test: - Electrical and mechanical performances shall be satisfied.	After storing at $-25\pm 2^{\circ}\text{C}$ for 96 hours in chamber, the switch shall be allowed to stand under normal temperature and humidity conditions for 1 hour, and the measurement shall be made within 1 hour after that. Water drops shall be eliminated.
8.2 High temperature	After test: - Electrical and mechanical performances shall be satisfied.	After storing at $85\pm 2^{\circ}\text{C}$ for 96 hours in chamber, the switch shall be allowed to stand under normal temperature and humidity conditions for 1 hour, and the measurement shall be made within 1 hour after that.
8.3 Heat and Humidity Resistance	After test: - Electrical and mechanical performances shall be satisfied.	After storing at $40\pm 2^{\circ}\text{C}$ , 90-95% RH for 96 hours in chamber, the switch shall be allowed to stand under normal temperature and humidity conditions for 1 hour, and the measurement shall be made within 1 hour after that. Water drops shall be eliminated.
8.4 Temperature Cycling	After test: - Electrical and mechanical performances shall be satisfied.	After 5 cycles of following conditions, the switch shall be allowed to stand under normal temperature and humidity conditions for 1 hour, and measurement shall be made within 1 hour after that. Water drops shall be eliminated. 

## 9. Remarks

Unless otherwise specified, the meaning of Electrically and mechanically performances shall be satisfied the following conditions in test standard:	
Contact Resistance	200 mΩ Max.
Insulation Resistance	10MΩ Min.
Dielectric Voltage	500 V AC for between terminals and 500V for between terminals and grounded parts, 1 minute.
Operating Force	The elastic force attenuation should be less than 30%
Other	The switch shall be no obvious abnormalities in appearance.
Important Warning	The switch can be used for very low current from 1mA. However, after using of over 50mA in current, we are not in a position to guarantee in very low current again. Therefore, kindly confirm before using.



## 10. Precautionsforuse

### 10.1 General:

The product is used mainly in electronic devices such as automatic devices, visual devices, home electrical appliances, information devices and communication settings. If the products is intended to be used for other endurance equipment requiring higher safety and reliability such as life support system, space and aviation devices, disaster and safety system, it's necessary to make verification of conformity or contact ZF for the details before using.

This technical specification (TS) has validity only in connection with the current drawing. Different details on the drawing have priority over the TS. Unless other information is given, all details described here have been defined under room conditions, which means normal conditions (normal pressure, ambient temperature, acc. to ISO 554) and the switches being tested in their rest position (not actuated). Details to the test conditions are described in the test specification.

ZF has the sole and final right of explanation for all the contents included in this technical specification as well as the other issues related to but not included in this technical specification.

### 10.2 Soldering and assembly:

- (1) If there is force applied on the terminal during soldering, the terminal may deform and the electrical characteristics may not be satisfied.
- (2) The soldering conditions should be confirmed according to the actual production environment.
- (3) Don't try to clean the switch with solvent or similar substance after the soldering process.
- (4) Don't operate the switch if it is still hot after soldering.
- (5) The switch might be damaged if using the water soluble flux, so make sure not to use such kind of flux.

### 10.3 Assembly structure and Mechanical design:

- (1) The dimensions for the holes and the pattern on PCB should refer to the recommended dimensions on the engineering drawing.
- (2) Operating Conditions:  
The allowable inclination of keying section is  $90\pm 3^\circ$ .
- (3) The switch might be broken if there is stress stronger than the specified is given on it. Take special care not to stress the switch beyond its specification.
- (4) If the switch is being used together other products, please confirm the compatibility of the specification, laws and regulations. Please also confirm the compatibility of switch to be installed in the systems, machines and devices used by customer. If you want to change the operating conditions of the switch, please consult with ZF in advance.

### 10.4 Minimum using load:

Switch is not recommended using in DC load under 5 V 1 mA, otherwise it may cause poor contact.

### 10.5 Operating Environment

(1) If the product is always used near sulfurate atmosphere or where exhaust gas from automobiles exists, it's necessary to pay more attention because the switch performance may be affected.

(2) If the below parts or materials are used in the module where the switch is installed, directions below should be followed:

A. For parts, rubber materials, adhesive agents, packing material and grease used for the mechanical part of the device, don't use any material that may generate gas of sulfurization or oxidization.

B. If silicon rubber, grease, adhesive agents and oil are used, choose the material that will not generate low molecular siloxane gas, because the low molecular siloxane gas may form silicon dioxide coat on the switch contact part, resulting of failing contact. Please contact ZF if you have to use above mentioned substance.

(3) Don't use the switch in the environment with high humidity or other bedewing possibility, as it may cause current leakage among the terminals.

(4) The effect caused by external dust intrusion: Because the switch was designed without dust-proof structure, it may have failed contact due to the dust intrusion from the outer environment. When using the switch, it's necessary to take dust-proof actions. Examples of dust intrusion, which should be prevented during the operation:

A. The chips and dust come from the notch or hole of PCB in process, or other wastes come from the protective material for PCB, such as newspaper, foam, polystyrene materials, may intrude into the switch.

B. The flux or solder powder being generated when stacking the PCB may intrude into the switch.

## 10.6 Storage Conditions:

- (1) In order to maintain the switch performance and the solderability, the switches must be stored under the following conditions:
  - ① Temperature of  $-10^{\circ}\text{C}$  to  $+40^{\circ}\text{C}$ , with humidity lower than 75%RH.
  - ② Avoid to store in the environment containing corrosive air.
  - ③ Avoid to keep in the location with direct sunlight.
- (2) Store using the standard packing without exerting force, self-lock switch should be kept in released position.
- (3) The standard storage period is 3 months, maximum up to 6 months, preferably to be used as soon as possible. After opening the package, you should put the remaining switches in a sealed plastic bag to isolate from damp and corrosive air, moistureproof measures are recommended.

## 10.7 Others

Please comply with the following guidelines:

- (1) The prohibited items which may cause fire and fume:
  - ① It might cause fire if the rating exceeds the specifications. Never use the switch beyond the rating. If the rating may exceed due to some abuse or abnormal usage, please take protective measures such as protective circuit to shut down the circuit when overload.
- (2) Precautions for the safety using of products:
  - ① Although we are confident in switch quality, we cannot deny that there's still little possibility of performance deterioration, short or open circuit, etc. Therefore, please make careful plan when application designing, to evaluate the effect when failure of individual part occurs, to ensure the product safety.
  - ② Prepare the system with protective circuit and protective devices for safety purposes.
  - ③ Prepare safety standby circuit to prevent the whole system shutdown caused by individual failure to ensure safety.

## 11 Appendix: Sketch of operating parameters

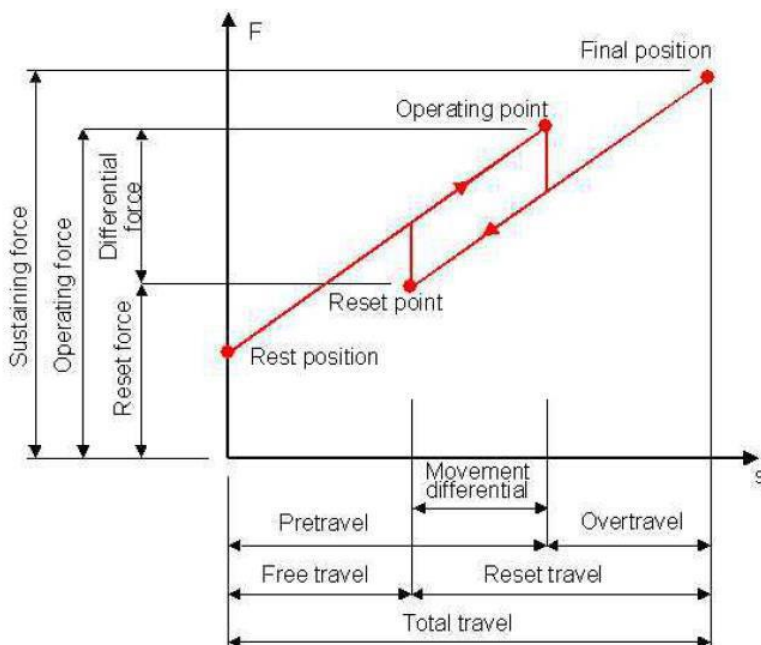

**GENERAL CHARACTERISTICS**

Operating Force	Max. 90gf
Release Force	Min. 10gf
Contact Resistance	Max. 50mΩ
Insulation Resistance	Min. 100mΩ 500VDC
Dielectric Voltage	500VAC 60 Sec.
Mechanical Life	50,000 Cycles
Electrical Life	30,000 Cycles
Rating	5-500mA 30VDC
Operating Temperature	-25 to 85°C

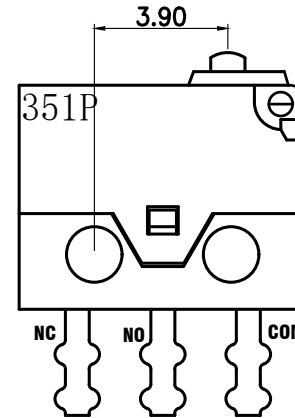
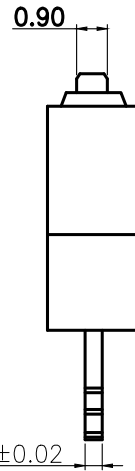
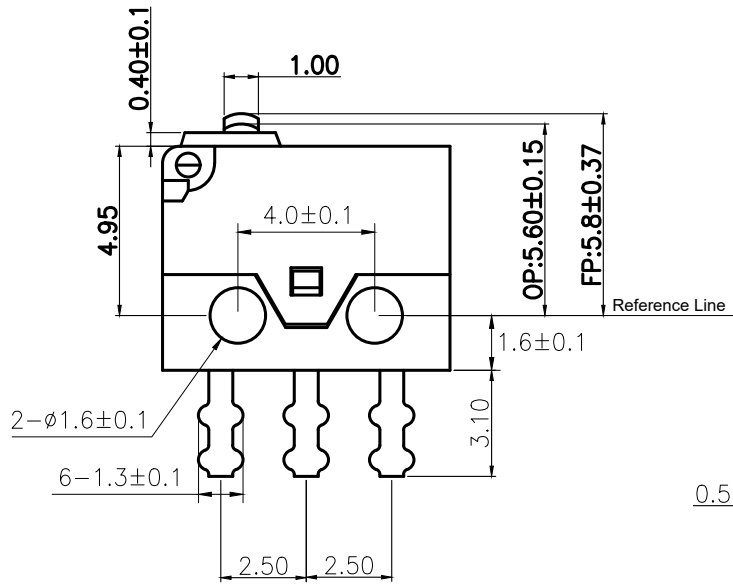
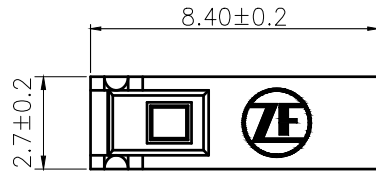

35 1 P  
 Zhuhai/China  
 2021 Year  
 35 Week

The date code could be printed on each lateral side randomly

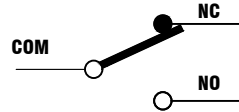

Circuit Diagram

Further details please refer to technical specification TS-DH-00001.  
 In case there are any deviations the drawing details have priority.

NO.	PARTS	MATERIALS
01	COVER	PA
02	BASE	PPA
03	ACTUATOR	PBT
04	CONTACT	Au ALLOY
05	MOVING BLADE	COPPER BERYLLIUM
06	TERMINAL (COM)	SILVER PLATE BRASS
07	TERMINAL (NO)	SILVER PLATE BRASS
08	TERMINAL (NC)	SILVER PLATE BRASS
09		



采埃孚电子(珠海)有限公司  
 ZF Electronics (Zhuhai) Company Limited

③					制图: DRAW	H,QIN	2020.12.11	TOLERANCE UNLESS SPECIFIED		系列 SERIES	DH 微动开关/SUBMINIATURE SWITCH						
②					设计: DESIGN	H,QIN	2020.12.11	WITHIN 1.5mm : ±0.1mm OVER 1.5mm : ±0.2mm			料号: TITLE	DHGC-B1AA					
①					审核: CHECKED	J,WANG	2020.12.16	材质: MATERIAL		图号: DWG. NO.	DHGC-B1AA						
记号 MARK.	变更内容 DEFINITION	修改 REVISE	核准 APPROVE	日期 DATE	批准: APPROVE	J,WANG	2020.12.16	单位: UNIT	mm	比例: SCALE	1:1	角法: PRDJ.	张数: SHEET	第1页,共1页	工程图 ENG. DWG	版本: REV.	A0

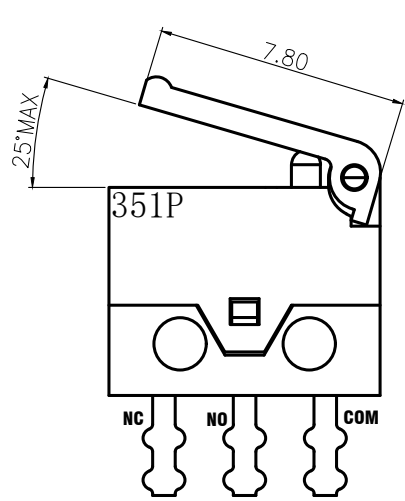
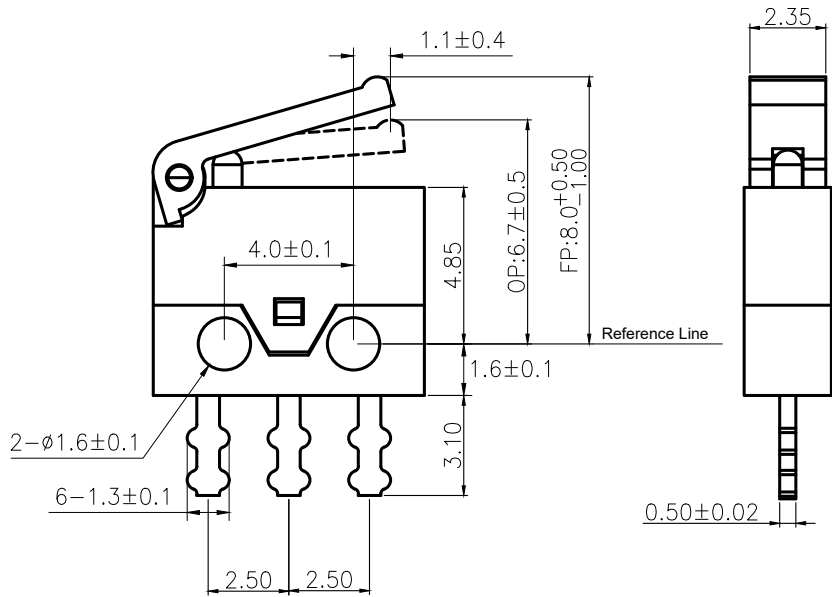
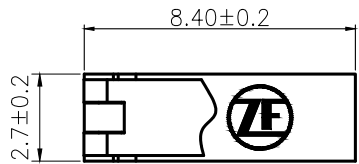

**GENERAL CHARACTERISTICS**

Operating Force	Max. 50gf
Release Force	Min. 3gf
Contact Resistance	Max. 50mΩ
Insulation Resistance	Min. 100mΩ 500VDC
Dielectric Voltage	500VAC 60 Sec.
Mechanical Life	50,000 Cycles
Electrical Life	30,000 Cycles
Rating	5-500mA 30VDC
Operating Temperature	-25 to 85°C

35 1 P  
 Zhuhai/China  
 2021 Year  
 35 Week

The date code could be printed on each lateral side randomly

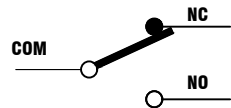

Circuit Diagram

Further details please refer to technical specification TS-DH-00001.  
 In case there are any deviations the drawing details have priority.

NO.	PARTS	MATERIALS
01	COVER	PA
02	BASE	PPA
03	ACTUATOR	PBT
04	AUX. ACTUATOR	PA46
05	CONTACT	Au ALLOY
06	MOVING BLADE	COPPER BERYLLIUM
07	TERMINAL (COM)	SILVER PLATE BRASS
08	TERMINAL (NO)	SILVER PLATE BRASS
09	TERMINAL (NC)	SILVER PLATE BRASS



采埃孚电子(珠海)有限公司  
 ZF Electronics (Zhuhai) Company Limited

制图: DRAW	H,QIN	2020.12.11	TOLERANCE UNLESS SPECIFIED		
设计: DESIGN	H,QIN	2020.12.11	WITHIN 1.5mm: ±0.1mm		
审核: CHECKED	J.WANG	2020.12.16	OVER 1.5mm: ±0.2mm	系列 SERIES	DH 微动开关/SUBMINIATURE SWITCH
批准: APPROVE	J.WANG	2020.12.16	材质: MATERIAL	料号: TITLE	DHGC-B1LA
记号 MARK.	变更内容 DEFINITION	修改 REVISE	核准 APPROVE	日期 DATE	批准: APPROVE

图号: DWG NO.		DHGC-B1LA	
张数: SHEET	第1页, 共1页	工程图 ENG. DWG	版本: REV.
			A0

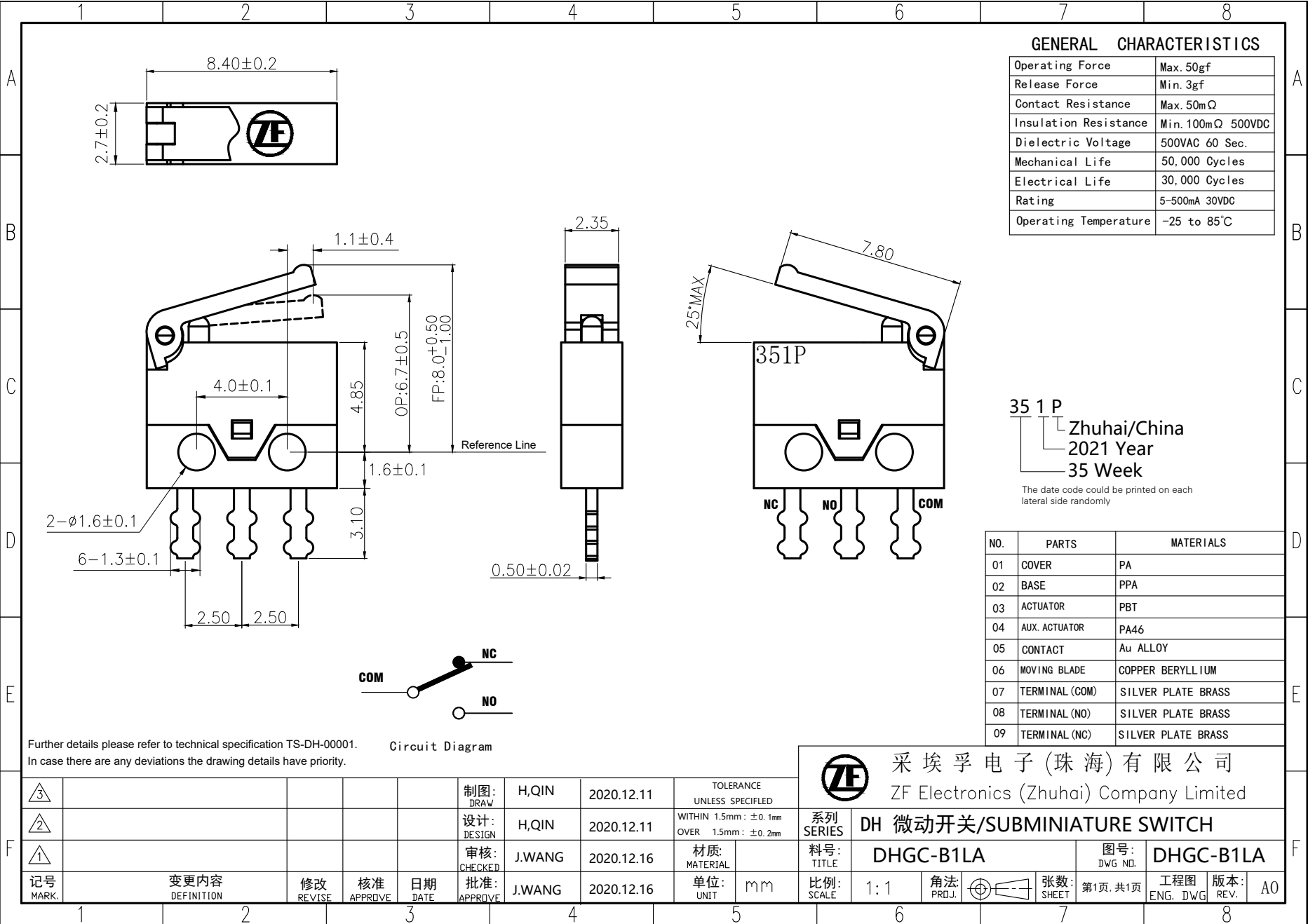

**GENERAL CHARACTERISTICS**

Operating Force	Max. 90gf
Release Force	Min. 10gf
Contact Resistance	Max. 50mΩ
Insulation Resistance	Min. 100mΩ 500VDC
Dielectric Voltage	500VAC 60 Sec.
Mechanical Life	50,000 Cycles
Electrical Life	30,000 Cycles
Rating	5-500mA 30VDC
Operating Temperature	-25 to 85°C

35 1 P  
 Zhuhai/China  
 2021 Year  
 35 Week  
 The date code could be printed on each lateral side randomly

NO.	PARTS	MATERIALS
01	COVER	PA
02	BASE	PPA
03	ACTUATOR	PBT
04	CONTACT	Au ALLOY
05	MOVING BLADE	COPPER BERYLLIUM
06	TERMINAL (COM)	SILVER PLATE BRASS
07	TERMINAL (NO)	SILVER PLATE BRASS
08	TERMINAL (NC)	SILVER PLATE BRASS
09		

**ZF** 采埃孚电子(珠海)有限公司  
 ZF Electronics (Zhuhai) Company Limited

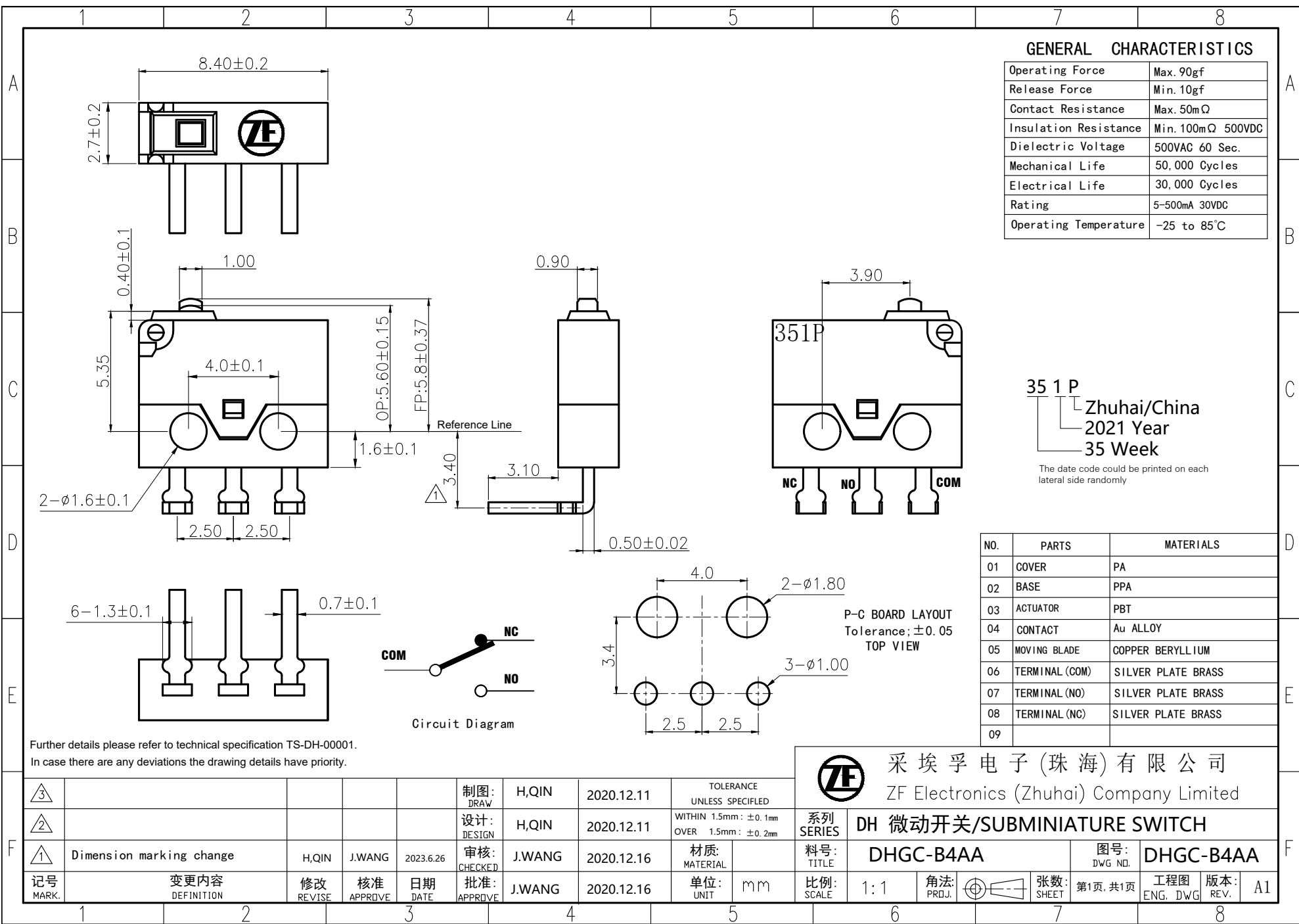

Further details please refer to technical specification TS-DH-00001.  
 In case there are any deviations the drawing details have priority.

③					制图: H,QIN	2020.12.11	TOLERANCE UNLESS SPECIFIED		系列: DH 微动开关/SUBMINIATURE SWITCH		料号: DHGC-B4AA		图号: DHGC-B4AA			
②				设计: H,QIN	2020.12.11	WITHIN 1.5mm: $\pm 0.1$ mm OVER 1.5mm: $\pm 0.2$ mm										
①	Dimension marking change	H,QIN	J.WANG	2023.6.26	审核: J.WANG	2020.12.16	材质: MATERIAL		比例: SCALE	1:1	角法: PRD.	张数: SHEET	第1页, 共1页	工程图: ENG. DWG	版本: REV.	A1
记号 MARK.	变更内容 DEFINITION	修改 REVISION	核准 APPROVE	日期 DATE	批准: J.WANG	2020.12.16	单位: UNIT	mm								

**GENERAL CHARACTERISTICS**

Operating Force	Max. 50gf
Release Force	Min. 3gf
Contact Resistance	Max. 50mΩ
Insulation Resistance	Min. 100mΩ 500VDC
Dielectric Voltage	500VAC 60 Sec.
Mechanical Life	50,000 Cycles
Electrical Life	30,000 Cycles
Rating	5-500mA 30VDC
Operating Temperature	-25 to 85°C

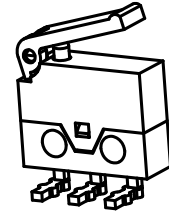

Left

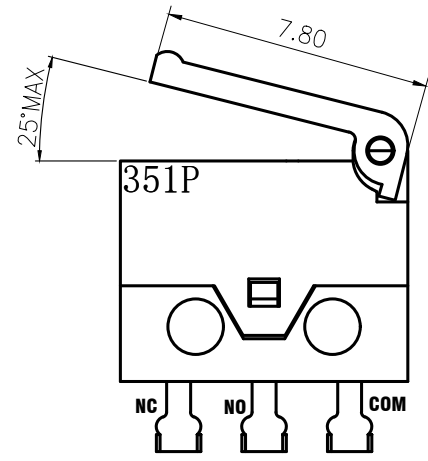

35 1 P  
 Zhuhai/China  
 2021 Year  
 35 Week

The date code could be printed on each lateral side randomly

NO.	PARTS	MATERIALS
01	COVER	PA
02	BASE	PPA
03	ACTUATOR	PBT
04	AUX. ACTUATOR	PA46
05	CONTACT	Au ALLOY
06	MOVING BLADE	COPPER BERYLLIUM
07	TERMINAL (COM)	SILVER PLATE BRASS
08	TERMINAL (NO)	SILVER PLATE BRASS
09	TERMINAL (NC)	SILVER PLATE BRASS

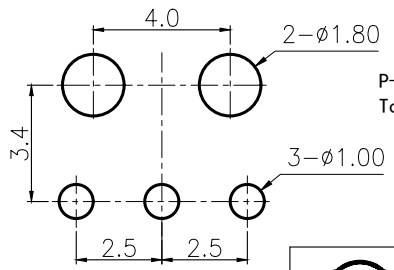
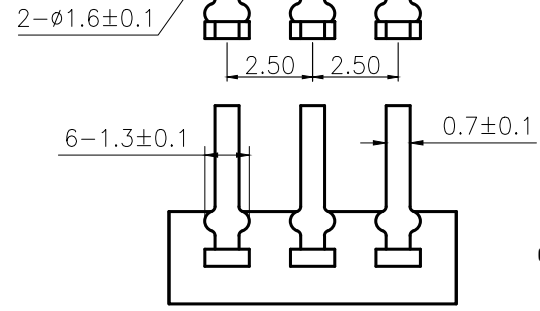
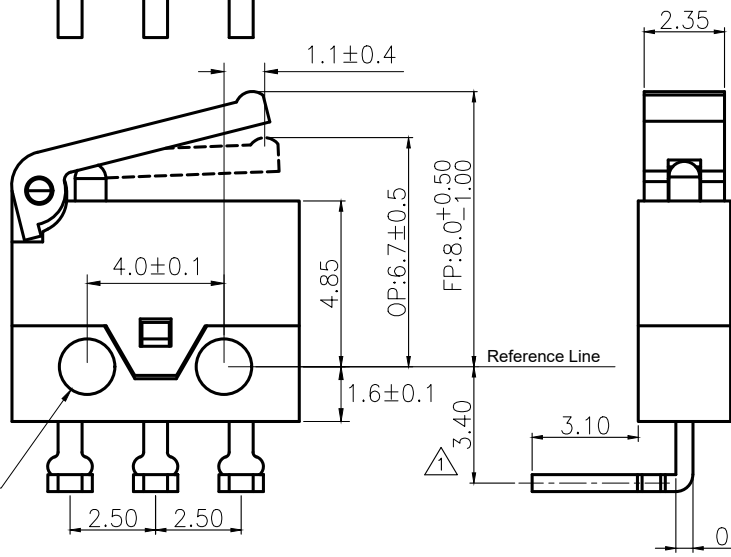
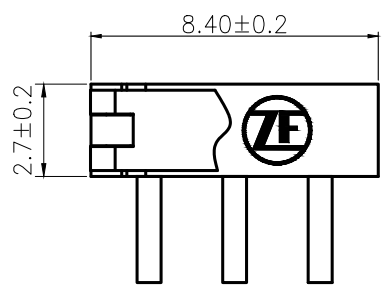

P-C BOARD LAYOUT  
 Tolerance: ±0.05  
 TOP VIEW

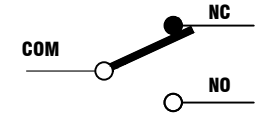

Circuit Diagram

Further details please refer to technical specification TS-DH-00001.  
 In case there are any deviations the drawing details have priority.



采埃孚电子(珠海)有限公司  
 ZF Electronics (Zhuhai) Company Limited

③					制图: DRAW	H,QIN	2020.12.11	TOLERANCE UNLESS SPECIFIED		系列 SERIES	DH 微动开关/SUBMINIATURE SWITCH	图号: DWG. NO.	DHGC-B4LA		
②					设计: DESIGN	H,QIN	2020.12.11	WITHIN 1.5mm : ±0.1mm OVER 1.5mm : ±0.2mm							
①	Dimension marking change	H,QIN	J.WANG	2023.6.26	审核: CHECKED	J.WANG	2020.12.16	材质: MATERIAL		料号: TITLE	DHGC-B4LA	张数: SHEET	第1页,共1页		
记号 MARK.	变更内容 DEFINITION	修改 REVISE	核准 APPROVE	日期 DATE	批准: APPROVE	J.WANG	2020.12.16	单位: UNIT	mm	比例: SCALE	1:1	角法: PRDJ.	工程图 ENG. DWG	版本: REV.	A1



**GENERAL CHARACTERISTICS**

Operating Force	Max. 90gf
Release Force	Min. 10gf
Contact Resistance	Max. 50mΩ
Insulation Resistance	Min. 100mΩ 500VDC
Dielectric Voltage	500VAC 60 Sec.
Mechanical Life	50,000 Cycles
Electrical Life	30,000 Cycles
Rating	5-500mA 30VDC
Operating Temperature	-25 to 85°C

35 1 P  
 Zhuhai/China  
 2021 Year  
 35 Week

The date code could be printed on each lateral side randomly

NO.	PARTS	MATERIALS
01	COVER	PA
02	BASE	PPA
03	ACTUATOR	PBT
04	CONTACT	Au ALLOY
05	MOVING BLADE	COPPER BERYLLIUM
06	TERMINAL (COM)	SILVER PLATE BRASS
07	TERMINAL (NO)	SILVER PLATE BRASS
08	TERMINAL (NC)	SILVER PLATE BRASS
09		



采埃孚电子(珠海)有限公司  
 ZF Electronics (Zhuhai) Company Limited

系列  
 SERIES

DH 微动开关/SUBMINIATURE SWITCH

料号  
 TITLE

DHGC-B5AA

图号  
 DWG. NO.

DHGC-B5AA

Further details please refer to technical specification TS-DH-00001.  
 In case there are any deviations the drawing details have priority.

③					制图: DRAW	H,QIN	2020.12.11	TOLERANCE UNLESS SPECIFIED								
②					设计: DESIGN	H,QIN	2020.12.11	WITHIN 1.5mm: ±0.1mm OVER 1.5mm: ±0.2mm								
①	Dimension marking change	H,QIN	J.WANG	2023.6.26	审核: CHECKED	J.WANG	2020.12.16	材质: MATERIAL		料号: TITLE	DHGC-B5AA	图号: DWG. NO.	DHGC-B5AA			
记号 MARK.	变更内容 DEFINITION	修改 REVISE	核准 APPROVE	日期 DATE	批准: APPROVE	J.WANG	2020.12.16	单位: UNIT	mm	比例: SCALE	1:1	角法: PRDJ.	张数: SHEET	工程图 ENG. DWG	版本: REV.	A1

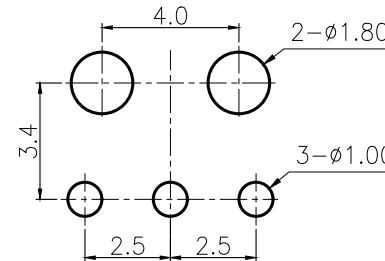
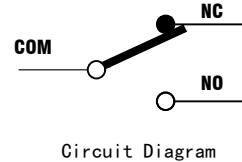
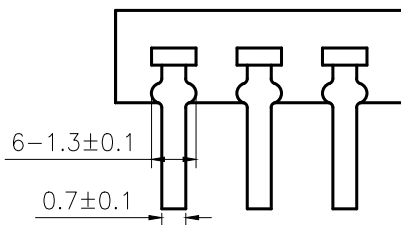
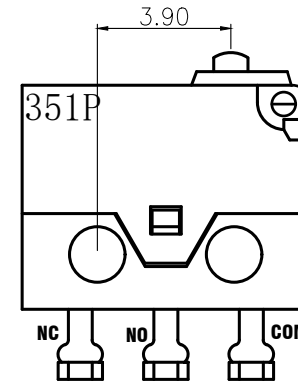
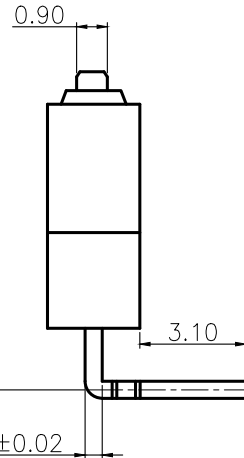
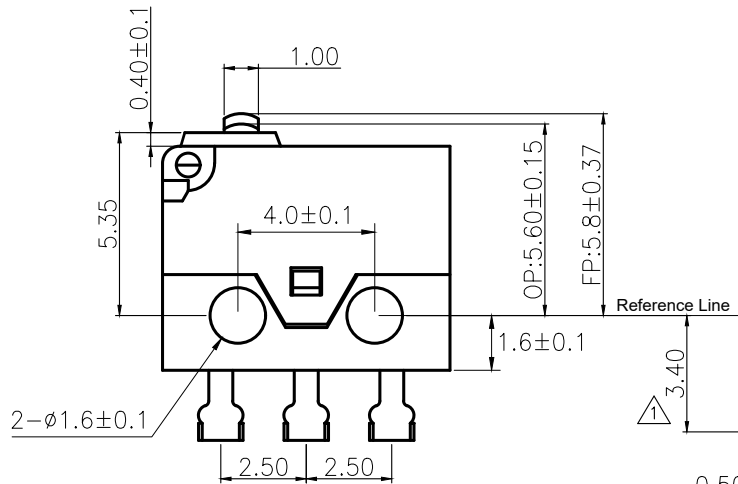
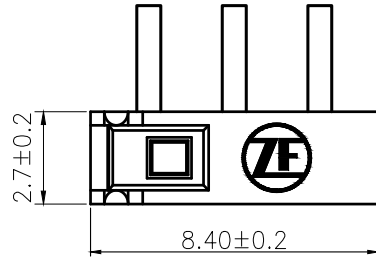

P-C BOARD LAYOUT  
 Tolerance: ±0.05  
 TOP VIEW

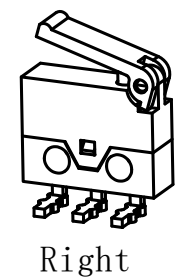
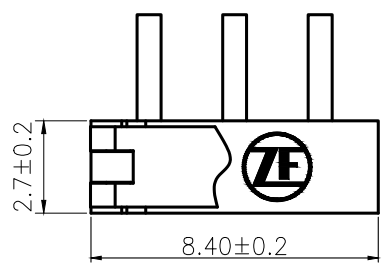

**GENERAL CHARACTERISTICS**

Operating Force	Max. 50gf
Release Force	Min. 3gf
Contact Resistance	Max. 50mΩ
Insulation Resistance	Min. 100mΩ 500VDC
Dielectric Voltage	500VAC 60 Sec.
Mechanical Life	50,000 Cycles
Electrical Life	30,000 Cycles
Rating	5-500mA 30VDC
Operating Temperature	-25 to 85°C

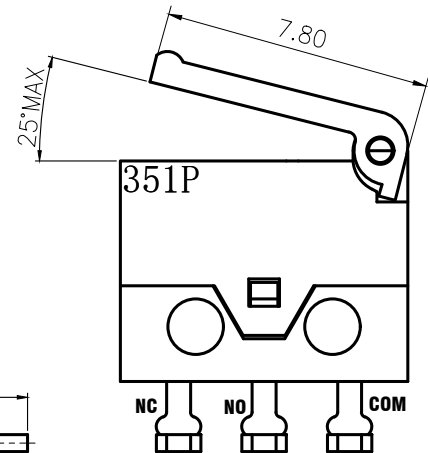
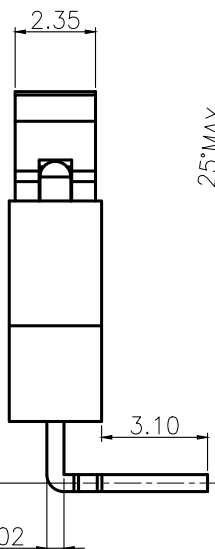
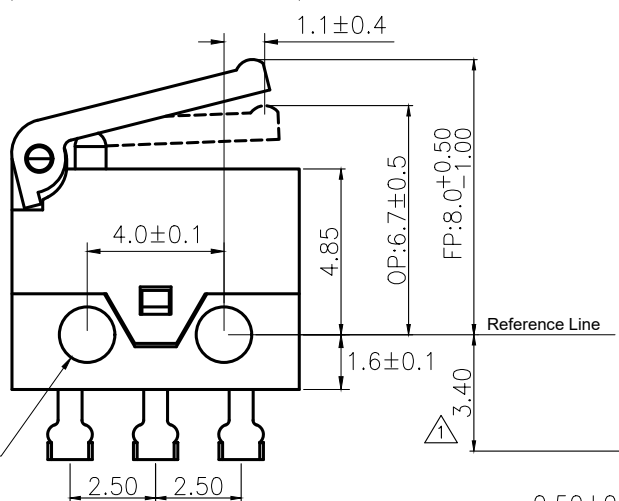

35 1 P  
 Zhuhai/China  
 2021 Year  
 35 Week

The date code could be printed on each lateral side randomly

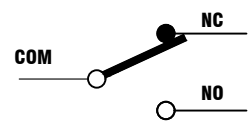
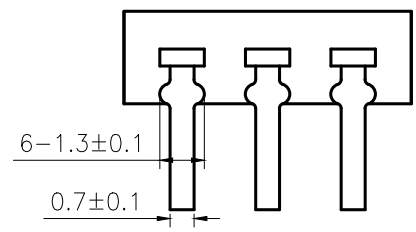

Circuit Diagram

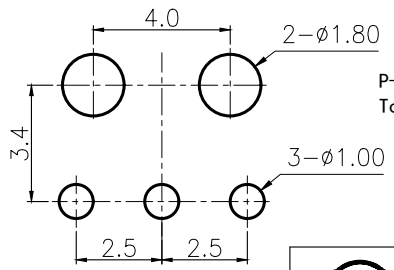

P-C BOARD LAYOUT  
 Tolerance; ±0.05  
 TOP VIEW

Further details please refer to technical specification TS-DH-00001.  
 In case there are any deviations the drawing details have priority.

NO.	PARTS	MATERIALS
01	COVER	PA
02	BASE	PPA
03	ACTUATOR	PBT
04	AUX. ACTUATOR	PA46
05	CONTACT	Au ALLOY
06	MOVING BLADE	COPPER BERYLLIUM
07	TERMINAL (COM)	SILVER PLATE BRASS
08	TERMINAL (NO)	SILVER PLATE BRASS
09	TERMINAL (NC)	SILVER PLATE BRASS

**ZF** 采埃孚电子(珠海)有限公司  
 ZF Electronics (Zhuhai) Company Limited

③					制图: DRAW	H,QIN	2020.12.11	TOLERANCE UNLESS SPECIFIED		系列 SERIES	DH 微动开关/SUBMINIATURE SWITCH						
②					设计: DESIGN	H,QIN	2020.12.11	WITHIN 1.5mm : ±0.1mm OVER 1.5mm : ±0.2mm									
①	Dimension marking change	H,QIN	J.WANG	2023.6.26	审核: CHECKED	J.WANG	2020.12.16	材质: MATERIAL		料号: TITLE	DHGC-B5LA	图号: DWG. NO.	DHGC-B5LA				
记号 MARK.	变更内容 DEFINITION	修改 REVISE	核准 APPROVE	日期 DATE	批准: APPROVE	J.WANG	2020.12.16	单位: UNIT	mm	比例: SCALE	1:1	角法: PRDJ.	张数: SHEET	第1页,共1页	工程图 ENG. DWG	版本: REV.	A1

**GENERAL CHARACTERISTICS**

Operating Force	Max. 90gf
Release Force	Min. 10gf
Contact Resistance	Max. 50mΩ
Insulation Resistance	Min. 100mΩ 500VDC
Dielectric Voltage	500VAC 60 Sec.
Mechanical Life	50,000 Cycles
Electrical Life	30,000 Cycles
Rating	5-500mA 30VDC
Operating Temperature	-25 to 85°C

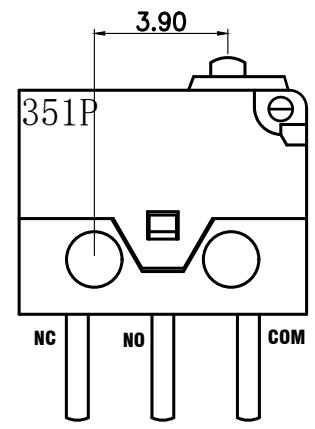
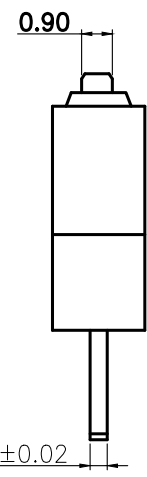
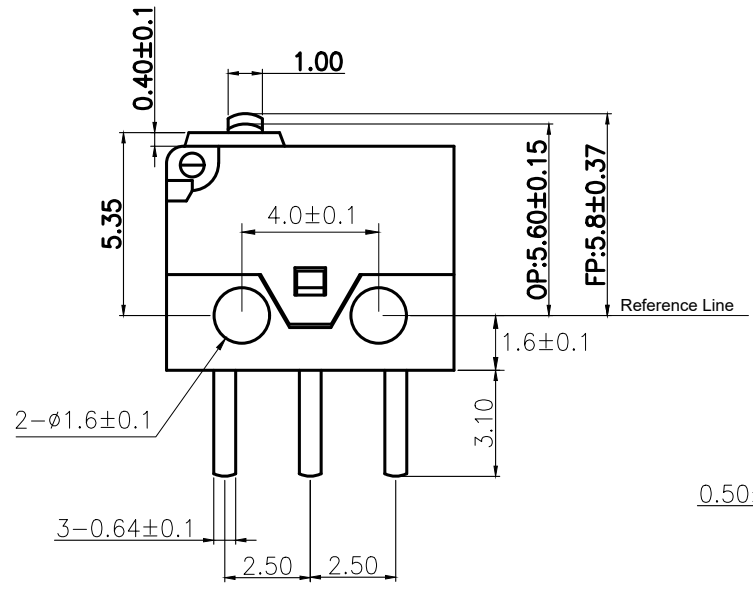
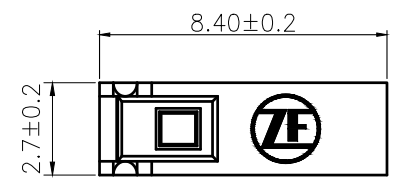

35 1 P  
 Zhuhai/China  
 2021 Year  
 35 Week  
 The date code could be printed on each lateral side randomly

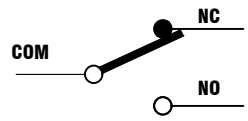

Further details please refer to technical specification TS-DH-00001.  
 In case there are any deviations the drawing details have priority.

Circuit Diagram

NO.	PARTS	MATERIALS
01	COVER	PA
02	BASE	PPA
03	ACTUATOR	PBT
04	CONTACT	Au ALLOY
05	MOVING BLADE	COPPER BERYLLIUM
06	TERMINAL (COM)	SILVER PLATE BRASS
07	TERMINAL (NO)	SILVER PLATE BRASS
08	TERMINAL (NC)	SILVER PLATE BRASS
09		

**ZF** 采埃孚电子(珠海)有限公司  
 ZF Electronics (Zhuhai) Company Limited

③					制图: DRAW	H,QIN	2020.12.11	TOLERANCE UNLESS SPECIFIED		系列 SERIES	DH 微动开关/SUBMINIATURE SWITCH					
②					设计: DESIGN	H,QIN	2020.12.11	WITHIN 1.5mm : ±0.1mm OVER 1.5mm : ±0.2mm	料号: TITLE		DHGC-C4AA					
①					审核: CHECKED	J,WANG	2020.12.16	材质: MATERIAL		图号: DWG. NO.	DHGC-C4AA					
记号 MARK.	变更内容 DEFINITION	修改 REVISE	核准 APPROVE	日期 DATE	批准: APPROVE	J,WANG	2020.12.16	单位: UNIT	mm	比例: SCALE	1:1	角法: PRDJ.	张数: SHEET	工程图 ENG. DWG	版本: REV.	A0

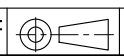

第1页, 共1页

**GENERAL CHARACTERISTICS**

Operating Force	Max. 50gf
Release Force	Min. 3gf
Contact Resistance	Max. 50mΩ
Insulation Resistance	Min. 100mΩ 500VDC
Dielectric Voltage	500VAC 60 Sec.
Mechanical Life	50,000 Cycles
Electrical Life	30,000 Cycles
Rating	5-500mA 30VDC
Operating Temperature	-25 to 85°C

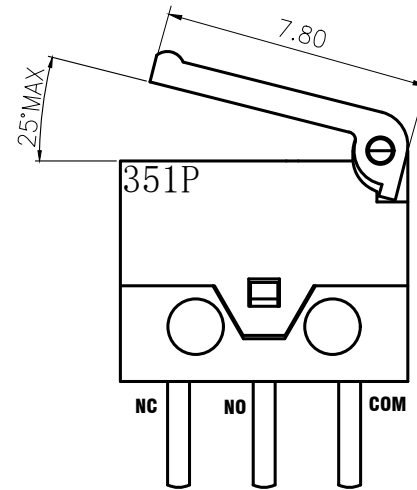
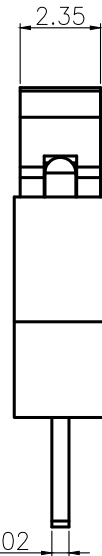
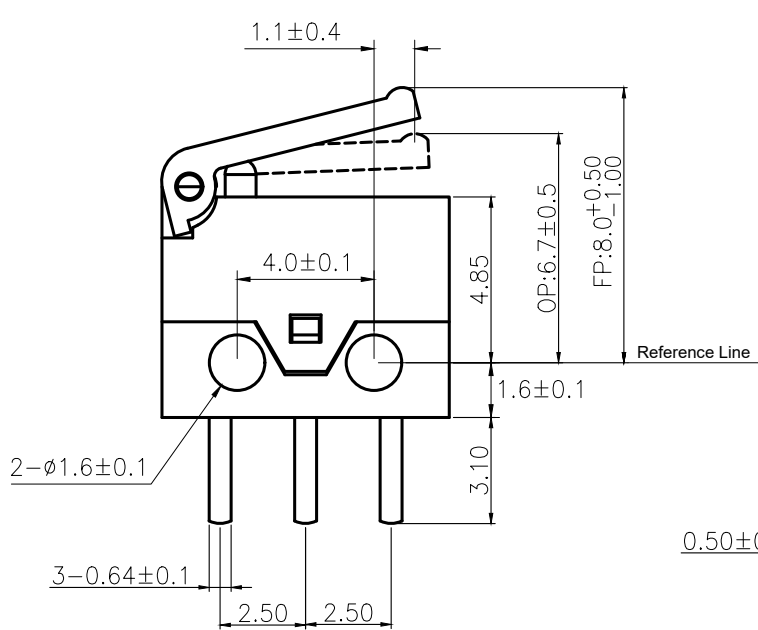
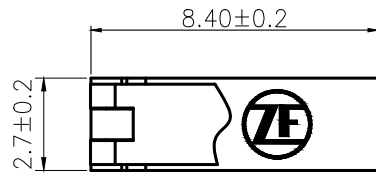

35 1 P  
 Zhuhai/China  
 2021 Year  
 35 Week

The date code could be printed on each lateral side randomly

NO.	PARTS	MATERIALS
01	COVER	PA
02	BASE	PPA
03	ACTUATOR	PBT
04	AUX. ACTUATOR	PA46
05	CONTACT	Au ALLOY
06	MOVING BLADE	COPPER BERYLLIUM
07	TERMINAL (COM)	SILVER PLATE BRASS
08	TERMINAL (NO)	SILVER PLATE BRASS
09	TERMINAL (NC)	SILVER PLATE BRASS

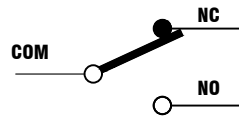

Circuit Diagram

P-C BOARD LAYOUT  
 Tolerance; ±0.05  
 TOP VIEW

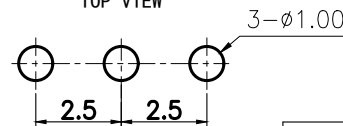

Further details please refer to technical specification TS-DH-00001.  
 In case there are any deviations the drawing details have priority.



采埃孚电子(珠海)有限公司  
 ZF Electronics (Zhuhai) Company Limited

③					制图: DRAW	H,QIN	2020.12.11	TOLERANCE UNLESS SPECIFIED		系列 SERIES	DH 微动开关/SUBMINIATURE SWITCH						
②					设计: DESIGN	H,QIN	2020.12.11	WITHIN 1.5mm : ±0.1mm OVER 1.5mm : ±0.2mm									
①					审核: CHECKED	J,WANG	2020.12.16	材质: MATERIAL		料号: TITLE	DHGC-C4LA	图号: DWG. NO.	DHGC-C4LA				
记号 MARK.	变更内容 DEFINITION	修改 REVISE	核准 APPROVE	日期 DATE	批准: APPROVE	J,WANG	2020.12.16	单位: UNIT	mm	比例: SCALE	1:1	角法: PRDJ.	张数: SHEET	第1页,共1页	工程图 ENG. DWG	版本: REV.	A0

**GENERAL CHARACTERISTICS**

Operating Force	Max. 90gf
Release Force	Min. 10gf
Contact Resistance	Max. 50mΩ
Insulation Resistance	Min. 100mΩ 500VDC
Dielectric Voltage	500VAC 60 Sec.
Mechanical Life	50,000 Cycles
Electrical Life	30,000 Cycles
Rating	5-500mA 30VDC
Operating Temperature	-25 to 85°C

35 1 P  
 Zhuhai/China  
 2021 Year  
 35 Week  
 The date code could be printed on each lateral side randomly

NO.	PARTS	MATERIALS
01	COVER	PA
02	BASE	PPA
03	ACTUATOR	PBT
04	CONTACT	Au ALLOY
05	MOVING BLADE	COPPER BERYLLIUM
06	TERMINAL (COM)	SILVER PLATE BRASS
07	TERMINAL (NO)	SILVER PLATE BRASS
08	TERMINAL (NC)	SILVER PLATE BRASS
09		

**ZF** 采埃孚电子(珠海)有限公司  
 ZF Electronics (Zhuhai) Company Limited

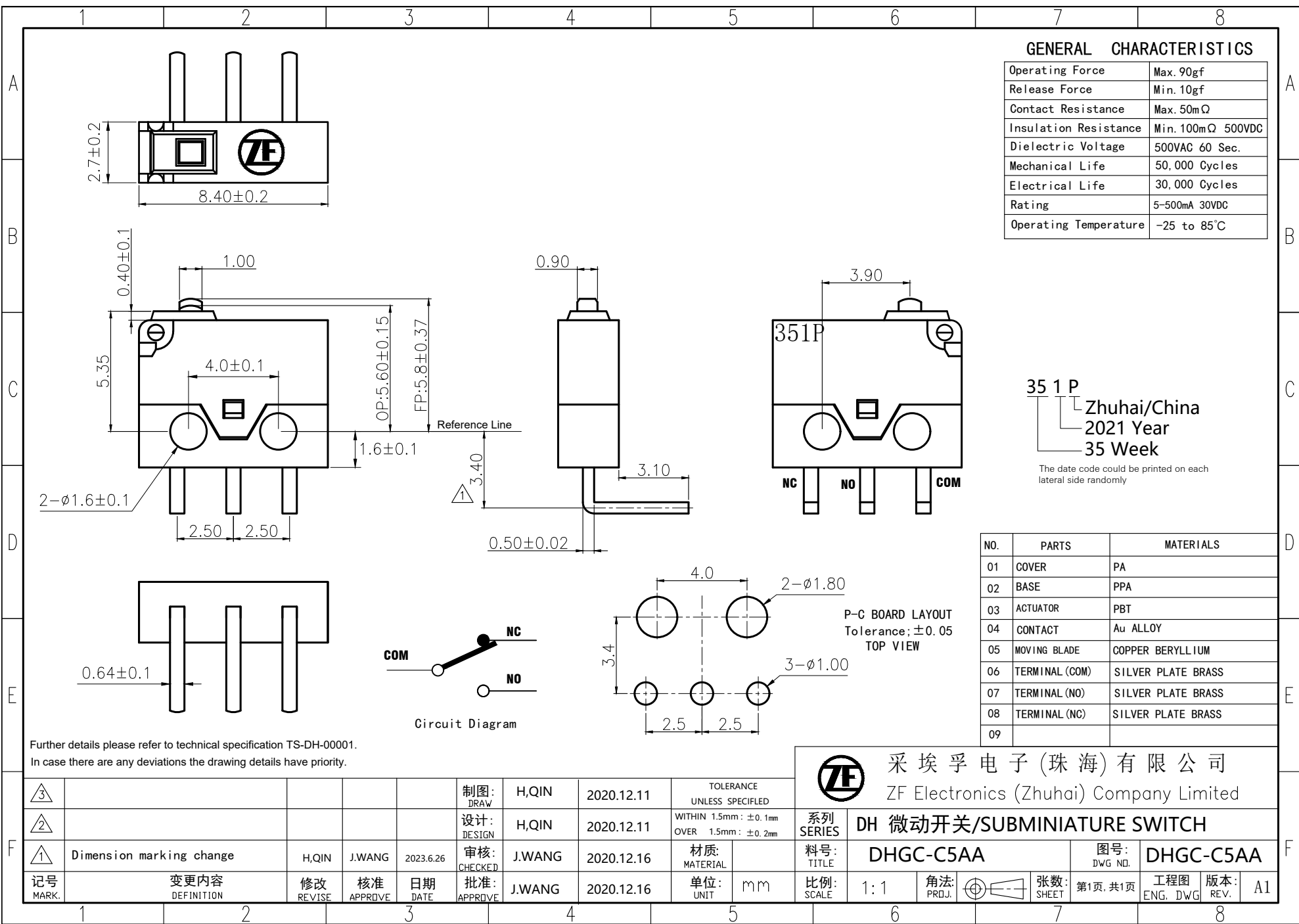

Further details please refer to technical specification TS-DH-00001.  
 In case there are any deviations the drawing details have priority.

③					制图: DRAW	H,QIN	2020.12.11	TOLERANCE UNLESS SPECIFIED		系列 SERIES	DH 微动开关/SUBMINIATURE SWITCH	
②					设计: DESIGN	H,QIN	2020.12.11	WITHIN 1.5mm: ±0.1mm OVER 1.5mm: ±0.2mm				
①	Dimension marking change	H,QIN	J.WANG	2023.6.26	审核: CHECKED	J.WANG	2020.12.16	材质: MATERIAL		料号: TITLE	DHGC-C5AA	
记号 MARK.	变更内容 DEFINITION	修改 REVISION	核准 APPROVE	日期 DATE	批准: APPROVE	J.WANG	2020.12.16	单位: UNIT	mm	比例: SCALE	1:1	角法: PROJ.
										张数: SHEET	第1页, 共1页	工程图 版本: REV. A1

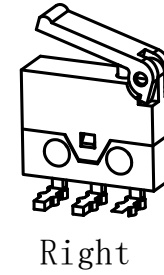
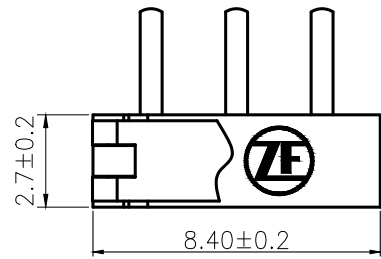

**GENERAL CHARACTERISTICS**

Operating Force	Max. 50gf
Release Force	Min. 3gf
Contact Resistance	Max. 50mΩ
Insulation Resistance	Min. 100mΩ 500VDC
Dielectric Voltage	500VAC 60 Sec.
Mechanical Life	50,000 Cycles
Electrical Life	30,000 Cycles
Rating	5-500mA 30VDC
Operating Temperature	-25 to 85°C

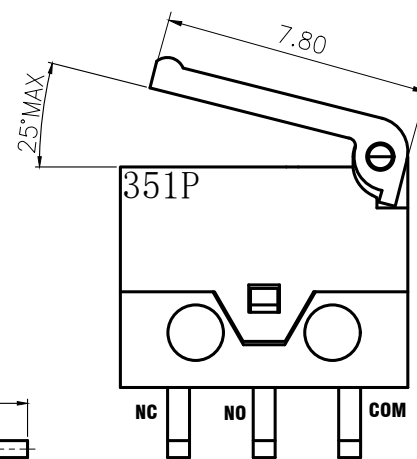
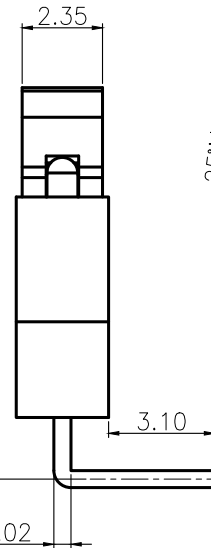
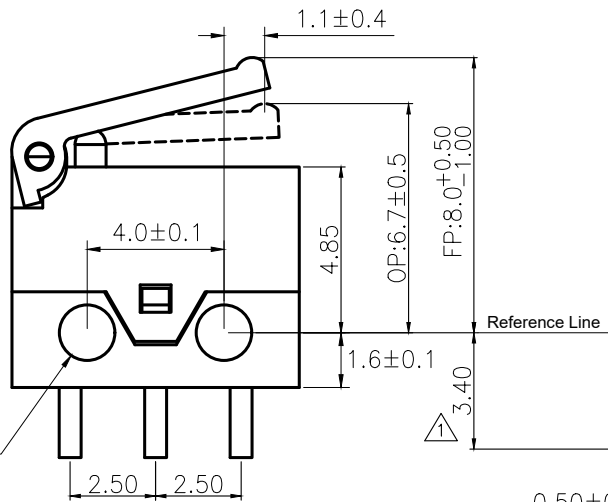

35 1 P  
 Zhuhai/China  
 2021 Year  
 35 Week

The date code could be printed on each lateral side randomly

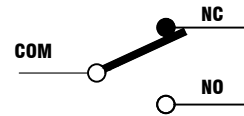
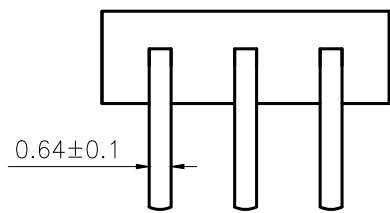

Circuit Diagram

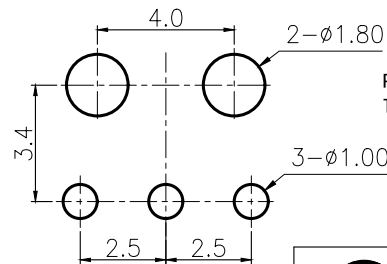

P-C BOARD LAYOUT  
 Tolerance; ±0.05  
 TOP VIEW

NO.	PARTS	MATERIALS
01	COVER	PA
02	BASE	PPA
03	ACTUATOR	PBT
04	AUX. ACTUATOR	PA46
05	CONTACT	Au ALLOY
06	MOVING BLADE	COPPER BERYLLIUM
07	TERMINAL (COM)	SILVER PLATE BRASS
08	TERMINAL (NO)	SILVER PLATE BRASS
09	TERMINAL (NC)	SILVER PLATE BRASS

Further details please refer to technical specification TS-DH-00001.  
 In case there are any deviations the drawing details have priority.



采埃孚电子(珠海)有限公司  
 ZF Electronics (Zhuhai) Company Limited

③					制图: DRAW	H,QIN	2020.12.11	TOLERANCE UNLESS SPECIFIED									
②					设计: DESIGN	H,QIN	2020.12.11	WITHIN 1.5mm : ±0.1mm OVER 1.5mm : ±0.2mm		系列 SERIES	DH 微动开关/SUBMINIATURE SWITCH						
①	Dimension marking change	H,QIN	J.WANG	2023.6.26	审核: CHECKED	J.WANG	2020.12.16	材质: MATERIAL		料号: TITLE	DHGC-C5LA		图号: DWG. NO.	DHGC-C5LA			
记号 MARK.	变更内容 DEFINITION	修改 REVISE	核准 APPROVE	日期 DATE	批准: APPROVE	J.WANG	2020.12.16	单位: UNIT	mm	比例: SCALE	1:1	角法: PRDJ.	张数: SHEET	第1页,共1页	工程图 ENG. DWG	版本: REV.	A1

**GENERAL CHARACTERISTICS**

Operating Force	Max. 90gf
Release Force	Min. 10gf
Contact Resistance	Max. 50mΩ
Insulation Resistance	Min. 100mΩ 500VDC
Dielectric Voltage	500VAC 60 Sec.
Mechanical Life	50,000 Cycles
Electrical Life	30,000 Cycles
Rating	5-500mA 30VDC
Operating Temperature	-25 to 85°C

35 1 P  
 Zhuhai/China  
 2021 Year  
 35 Week  
 The date code could be printed on each lateral side randomly

NO.	PARTS	MATERIALS
01	COVER	PA
02	BASE	PPA
03	ACTUATOR	PBT
04	CONTACT	Au ALLOY
05	MOVING BLADE	COPPER BERYLLIUM
06	TERMINAL (COM)	SILVER PLATE BRASS
07	TERMINAL (NO)	SILVER PLATE BRASS
08	TERMINAL (NC)	SILVER PLATE BRASS
09		

**ZF** 采埃孚电子(珠海)有限公司  
 ZF Electronics (Zhuhai) Company Limited

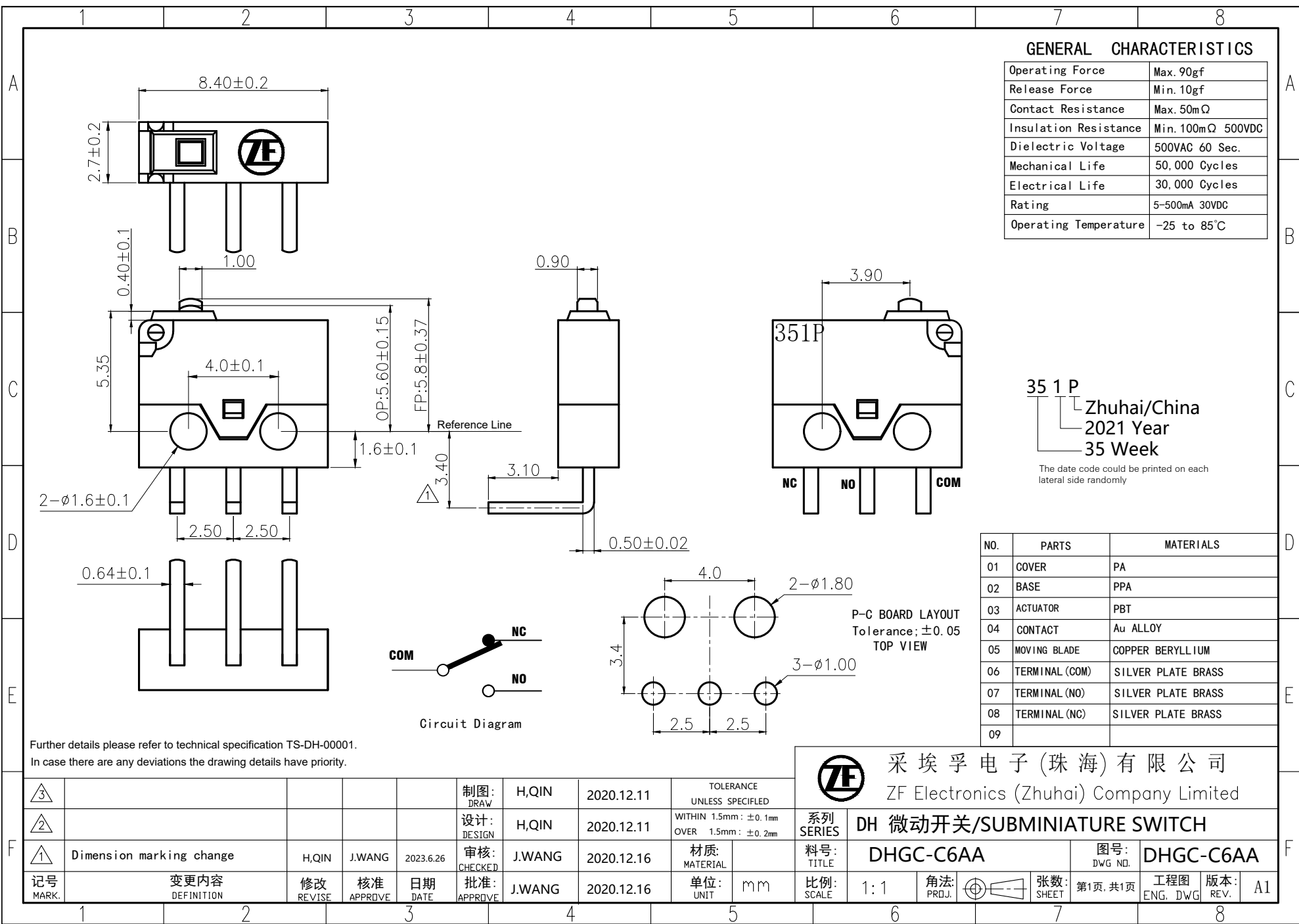

Further details please refer to technical specification TS-DH-00001.  
 In case there are any deviations the drawing details have priority.

③					制图: DRAW	H,QIN	2020.12.11	TOLERANCE UNLESS SPECIFIED		系列 SERIES	DH 微动开关/SUBMINIATURE SWITCH		图号: DWG. NO.	DHGC-C6AA	
②					设计: DESIGN	H,QIN	2020.12.11	WITHIN 1.5mm: ±0.1mm OVER 1.5mm: ±0.2mm			料号: TITLE	DHGC-C6AA		张数: SHEET	第1页, 共1页
①	Dimension marking change	H,QIN	J.WANG	2023.6.26	审核: CHECKED	J.WANG	2020.12.16	材质: MATERIAL		比例: SCALE	1:1	角法: PROJ.	工程图: ENG. DWG	版本: REV.	A1
记号 MARK.	变更内容 DEFINITION	修改 REVISION	核准 APPROVE	日期 DATE	批准: APPROVE	J.WANG	2020.12.16	单位: UNIT	mm			张数: SHEET			

**GENERAL CHARACTERISTICS**

Operating Force	Max. 50gf
Release Force	Min. 3gf
Contact Resistance	Max. 50mΩ
Insulation Resistance	Min. 100mΩ 500VDC
Dielectric Voltage	500VAC 60 Sec.
Mechanical Life	50,000 Cycles
Electrical Life	30,000 Cycles
Rating	5-500mA 30VDC
Operating Temperature	-25 to 85°C

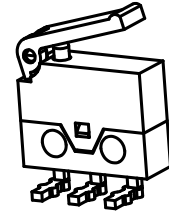

Left

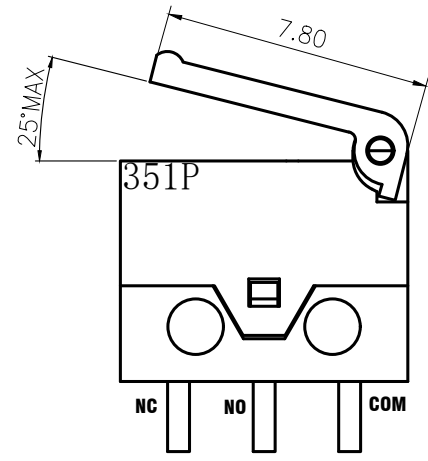

35 1 P  
 Zhuhai/China  
 2021 Year  
 35 Week

The date code could be printed on each lateral side randomly

NO.	PARTS	MATERIALS
01	COVER	PA
02	BASE	PPA
03	ACTUATOR	PBT
04	AUX. ACTUATOR	PA46
05	CONTACT	Au ALLOY
06	MOVING BLADE	COPPER BERYLLIUM
07	TERMINAL (COM)	SILVER PLATE BRASS
08	TERMINAL (NO)	SILVER PLATE BRASS
09	TERMINAL (NC)	SILVER PLATE BRASS

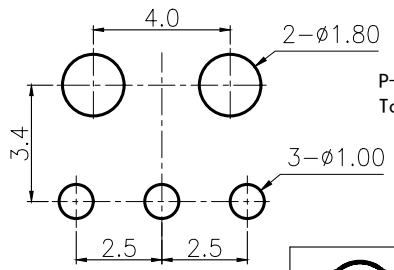
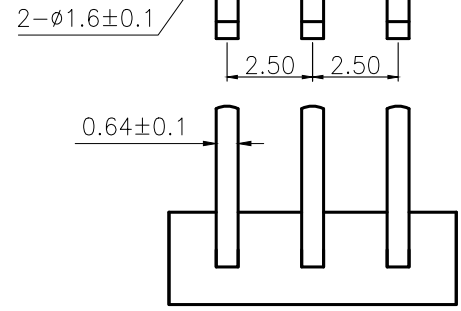
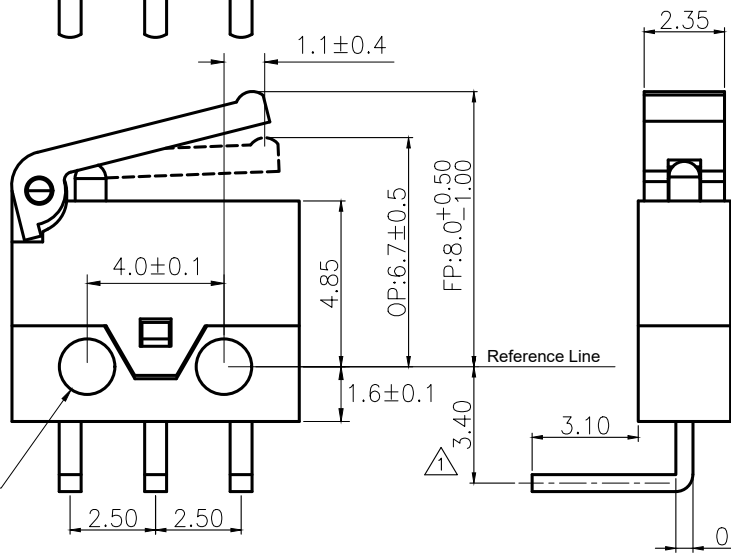
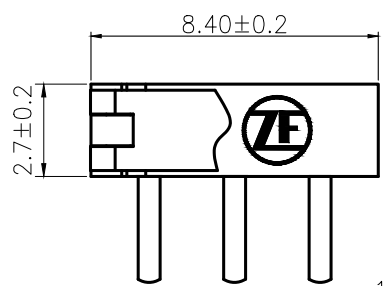

P-C BOARD LAYOUT  
 Tolerance: ±0.05  
 TOP VIEW

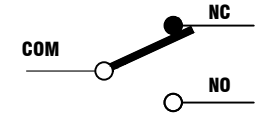

Circuit Diagram

Further details please refer to technical specification TS-DH-00001.  
 In case there are any deviations the drawing details have priority.



采埃孚电子(珠海)有限公司  
 ZF Electronics (Zhuhai) Company Limited

③					制图: DRAW	H,QIN	2020.12.11	TOLERANCE UNLESS SPECIFIED		系列 SERIES	DH 微动开关/SUBMINIATURE SWITCH	图号: DWG. NO.	DHGC-C6LA		
②					设计: DESIGN	H,QIN	2020.12.11	WITHIN 1.5mm : ±0.1mm OVER 1.5mm : ±0.2mm							
①	Dimension marking change	H,QIN	J.WANG	2023.6.26	审核: CHECKED	J.WANG	2020.12.16	材质: MATERIAL		料号: TITLE	DHGC-C6LA	张数: SHEET	第1页,共1页		
记号 MARK.	变更内容 DEFINITION	修改 REVISE	核准 APPROVE	日期 DATE	批准: APPROVE	J.WANG	2020.12.16	单位: UNIT	mm	比例: SCALE	1:1	角法: PRDJ.	工程图 ENG. DWG	版本: REV.	A1