

SENSORS





Contents

MP1	MAGNETIC PROXIMITY SENSORS, HALL	Page	4 / 5
MP2	MAGNETIC PROXIMITY SENSORS, REED	Page	6 / 7
GS	GEARTOOTH SPEED SENSORS	Page	8 - 10
SD	GEARTOOTH SPEED AND DIRECTION SENSORS	Page	11
SD	SPEED AND DIRECTION SENSOR KIT	Page	12 / 13
AN	ANGLE POSITION SENSORS	Page	14 / 15
LIN	LINEAR POSITION SENSORS	Page	16
VN	DIGITAL VANE SENSORS	Page	17
	COMPENDIUM AND ADDITIONAL INFORMATION	Page	18 - 21

SENSORS FROM ZF deliver unmatched performance and reliability across a wide range of applications. They serve as economical solutions that are suitable for the most rigorous environments, including extreme temperatures, humidity, thermal shock, and vibrations. Choose a standard product or partner with ZF developers as they help you to create a custom solution. Customers in the automotive, appliance, and medical industries rely on ZF sensors for compact designs and durable products.

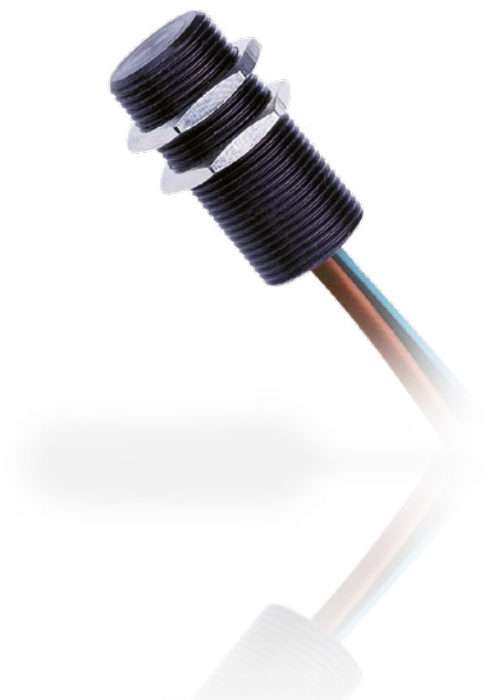

MAGNETIC PROXIMITY SENSORS, HALL

Integrated position sensors based on Hall technology respond to magnetic fields generated by permanent magnets. They provide a sinking current output.

Features

- Solid state reliability
- RoHs compliant
- Stable output signal over the entire operating temperature range (MP1007, MP1013, MP1021)
- Open collector (sinking or NPN) output can be used with bipolar or CMOS logic circuits with suitable pull-up resistor (MP1007, MP1013, MP1021)
- These sensors require the use of an external pull-up resistor, the value of which depends on the supply voltage.

Typical applications

- Door position & interlock
- Limit switch
- Flow/speed measurement
- Building security
- Pedal switch

MP1007

Magnetic proximity sensor in an adjustable cylinder housing

- Compatible with unregulated power supply
- South pole sensitive
- Reverse battery protected up to -24 V DC
- IP67

MP1013

Magnetic Hall-effect proximity sensor with a convenient snap-fit mounting

- South pole sensitive
- Unipolar device (MP101301, MP101302)
- Latching version available (MP101303)
- Reverse battery protected up to -24 V DC
- Snap-fit mounting
- IP67



Technical data

Series	MP1007	MP1013
Dimensions L/W/H mm (inches)	Cylinder length 15/32 – 32 TPI x 25.40 (1,000)	13.97 x 7.75 x 4.44 (0.550 x 0.305 x 0.175)
Operating voltage range (V DC)	3.8 – 24	3.8 – 24
Supply current (mA max.)	7.5 mA	7.5 mA
Operating temperature range (°C)	-40 to +150°C	-40 to +85°C
Activation threshold (Gauss)	245	245
Deactivation threshold (Gauss)	60	60
Output saturation voltage (mV max.)	400	400
Output current (mA max.)	25	25

MP1014

Digital Hall-effect sensor in a low-profile, flange-mount housing

- South pole sensitive
- Unipolar device (MP101401, MP101402)
- Latching version available (MP101403)
- Low-profile design
- IP65

MP1021

Digital Hall-effect sensor in a compact, plastic, flange-mount housing

- Flange-mount housing
- North pole sensitive
- Unipolar switching
- Reverse battery protected up to 24 V DC
- 3-wire OC output
- IP67

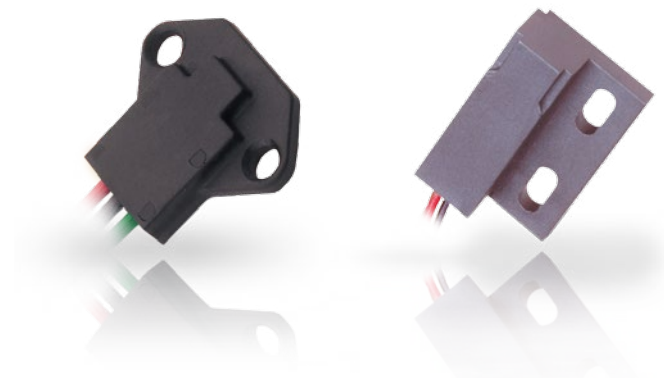
**Technical data**

Series	MP1014	MP1021
Dimensions L/W/H mm (inches)	17.27 x 21.72 x 3.30 (0.680 x 0.855 x 0.130)	28.58 x 19.05 x 9.53 (1.125 x 0.750 x 0.375)
Operating voltage range (V DC)	4.5 – 18	4.5 – 24
Supply current (mA max.)	5.2 mA	12 mA
Operating temperature range (°C)	–40 to +85 °C	–40 to +85 °C
Activation threshold (Gauss)	139 (south)	400 (north)
Deactivation threshold (Gauss)	47 (south)	195 (north)
Output saturation voltage (mV max.)	400	500
Output current (mA max.)	20	20

MAGNETIC PROXIMITY SENSORS, REED

Reed-based sensors with normally open or normally closed contacts that change states when a magnetic field is applied. These sensors act as non-latching electrical switches.

Features

- Hermetically sealed for long life
- Zero power consumption in standby
- Suitable for DC and AC circuits
- Power rating (W max.) 10 W with normally open, 3 W with normally closed and changeover
- IP65
- RoHS compliant

Typical applications

- Door position & interlock
- Limit switch
- Flow/speed measurement
- Building security
- Pedal switch

MP2007

Omnipolar Reed-based sensor in an aluminum threaded housing

- Operate/release distances when using a magnetic actuator
AS101001: 3.81 mm – 12.7 mm (0.15" – 0.5")
- Mounting hardware included

MP2017

Omnipolar Reed-based sensor in an aluminum threaded housing

- Operate/release distances when using a magnetic actuator
AS201701: 3.81 mm – 12.7 mm (0.15" – 0.5")



Technical data

Series	MP2007	MP2017
Dimensions L/W/H mm (inches)	25.40 x 11.90 dia. (1.00 x 0.469 dia.)	25.40 x 6.16 dia. (1.00 x 0.243 dia.)
Switching voltage normally open (V AC/V DC max.)	AC 175 / DC 175	AC 175 / DC 175
Switching voltage normally closed/changeover (V AC/V DC max.)	30 / 30	30 / 30
Switching current normally open (Amp max.)	0.5	0.5
Switching current normally closed/changeover (Amp max.)	0.2	0.2
Contact configuration	S.P.S.T.-NO, S.P.S.T.-NC, S.P.D.T.	S.P.S.T.-NO, S.P.S.T.-NC, S.P.D.T.
Min. operate distance mm (inches)	3.81 (0.150)	3.81 (0.150)
Max. release distance mm (inches)	12.7 (0.500)	12.7 (0.500)
Temperature range (°C)	-40 to +105 °C	-40 to +105 °C
Breakdown voltage (V DC min.)	200	200

MP2018

Omnipolar Reed-based sensor in a compact plastic housing

- Operate/release distances when using a magnetic actuator AS201801:
6.35 mm – 17.8 mm (0.25" – 0.7")
- Flange mount

MP2019

Omnipolar Reed-based sensor in in plastic housing

- Operate/release distances when using a magnetic actuator AS201901:
10.16 mm – 22.86 mm (0.4" – 0.9")
- Flange mount

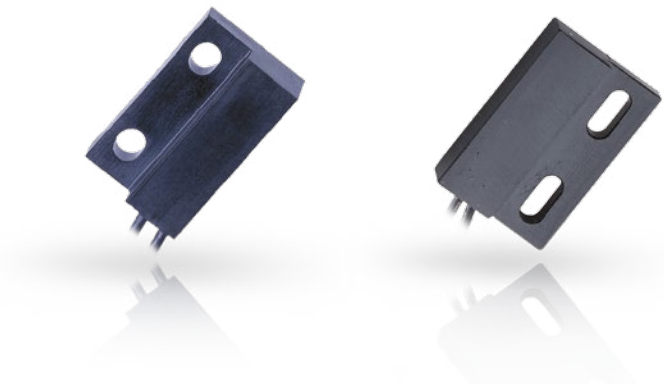
**Technical data**

Series	MP2018	MP2019
Dimensions L/W/H mm (inches)	23.01 x 13.97 x 5.99 (0.906 x 0.550 x 0.236)	28.58 x 19.10 x 6.35 (1.125 x 0.750 x 0.250)
Switching voltage normally open (V AC/V DC max.)	AC 175 / DC 175	AC 175 / DC 175
Switching voltage normally closed / changeover (V AC/V DC max.)	30 / 30	30 / 30
Switching current normally open (Amp max.)	0.5	0.5
Switching current normally closed / changeover (Amp max.)	0.2	0.2
Contact configuration	S.P.S.T.-NO, S.P.S.T.-NC	S.P.S.T.-NO, S.P.S.T.-NC, S.P.D.T.
Min. operate distance mm (inches)	6.35 (0.250)	10.16 (0.400)
Max. release distance mm (inches)	17.8 (0.700)	22.86 (0.900)
Temperature range (°C)	-40 to +105 °C	-40 to +105 °C
Breakdown voltage (V DC min.)	200	200

GEARTOOTH SPEED SENSORS

Hall-effect sensors designed for use in applications where ferrous edge detection/near zero speed sensing is needed. They provide a sinking current output.

Features

- Typical airgap of 1.5 mm with recommended target type
- Senses motion of ferrous geartooth targets
- Near zero speed sensing capability
- IP67
- RoHS compliant
- These sensors require the use of an external pull-up resistor, the value of which depends on the supply voltage.

Typical applications

- Speedometers
- Anti-lock braking systems
- Exercise equipment
- CNC machine tools

GS1001–GS1002

Circuit-protected, Hall-effect geartooth sensor in a stainless-steel housing

- Immune to rotational alignment
- 10-bit dynamic threshold detection for automatically adjusting magnetic range, self-compensating to target geometry, immune to target run out
- Compatible with unregulated power supply
- Internal circuit protection to IEC 1000, requirements for heavy industrial applications, including immunity to electrostatic discharge, transient voltage, radiated electrical fields, conducted electrical energy, electromagnetic fields
- Measurement independent of direction of rotation
- Suitable for high-speed applications



Technical data

Series	GS1001 – GS1002
Dimensions L/W/H mm (inches)	Barrel length 65.50 (2.580)
Thread	M12-1
Operating voltage range (V DC)	5.0 – 24
Supply current (mA max.)	6
Operating temperature range (°C)	– 40 to + 125 °C
Output saturation voltage (mV max.)	400
Output current (mA max.)	20
Reverse battery protected	up to – 24 V DC

GS1005–GS1007

Hall-effect speed sensor in an aluminum housing

- Immune to rotational alignment
- 10-bit dynamic threshold detection for automatically adjusting magnetic range, self-compensating to target geometry, immune to target run out
- Compatible with unregulated power supply
- Hard coat anodized aluminum housing



Technical data

Series	GS1005	GS1007
Dimensions L/W/H mm (inches)	Barrel length 65.5 (2.58)	Barrel length 15/32–32 TPI x 25.40 (1,000)
Thread	M12-1	15/32–32
Operating voltage range (V DC)	5.0–24	5.0–24
Supply current (mA max.)	6	6
Operating temperature range (°C)	–40 to +125 °C	–40 to +125 °C
Output saturation voltage (mV max.)	400	400
Output current (mA max.)	20	20
Reverse battery protected	up to –24 V DC	up to –24 V DC

GEARTOOTH SPEED SENSORS

Features

- Typical airgap of 1.5 mm with recommended target type
- Highly immune to rotational alignment
- IP67
- RoHS compliant
- These sensors require the use of an external pull-up resistor, the value of which depends on the supply voltage.

Typical applications

- Speedometers
- Anti-lock braking systems
- Exercise equipment
- CNC machine tools

GS1012

Speed sensor in a plastic housing rated to 140 °C

- Resistant to fuels, solvents, and lubricants associated with engines, transmissions, brakes, and chassis systems
- Single Hall design is immune to alignment issues, thus allowing unlimited mounting positions
- Suitable for speeds from near zero to 15 kH

GS1023

Speed sensor in a plastic housing

- Installs into a standard M20 x 1.5 port
- Resistant to fuels, solvents, and lubricants associated with engines, transmissions, brakes, and chassis systems
- Supplied with installed Viton O-ring
- Single Hall design is immune to alignment issues, thus allowing unlimited mounting positions
- Suitable for speeds from near zero to 15 kH



Technical data

Series	GS1012	GS1023
Dimensions L/W/H mm (inches)	60.50 x 36.30 x 18.90 dia. (2.38 x 1.43 x 0.75 dia.)	71.30 x 24.00 x 17.7 dia. (2.81 x 0.94 x 0.70 dia.)
Thread	–	M20 x 1.5 (0.60) and R 0.6 +0.3 / -0 (0.02 +0.01 / -0)
Operating voltage range (V DC)	5.0–24	5.0–24
Supply current (mA max.)	6	3 mA normal, 6 mA max.
Operating temperature range (°C)	–40 to +140 °C	–40 to +140 °C
Output saturation voltage (mV max.)	600	n/s
Output current (mA max.)	25	25
Connector	Delphi Metri-Pack 150	Delphi Metri-Pack 150

GEARTOOTH SPEED AND DIRECTION SENSORS

Has two Hall-effect sensors, one that detects speed and, in combination with the second, detects the direction of movement. They use an open collector (sinking) output. The speed output switches from high (Vcc) to low (near zero) when it detects a transition from “no-tooth” to “tooth present”.

Features

- Separate digital outputs for speed and direction
- From near zero speed up to 15 kHz sensing capability
- Plastic flange-mount housing rated to 125 °C
- Typical airgap of 1.5 mm with recommended target type
- IP67
- RoHS compliant
- These sensors require the use of an external pull-up resistor, the value of which depends on the supply voltage.

Typical applications

- Wheel speed and direction
- Hoist speed and direction
- Transmission speed and direction
- Industrial feedback and control

SD1012

Geartooth speed and direction sensor in a plastic housing

SD5012

Geartooth speed and direction sensor in a plastic housing

- Immune to target run out



Technical data

Series	SD1012	SD5012
Dimensions L/W/H mm (inches)	76.20 x 24.80 x 17.86 dia. (3.0 x 0.976 x 0.703 dia.)	75.90 x 18.92 dia. (2.988 x 0.94 x 0.74 dia.)
Operating voltage range (V DC)	4.75–24	5.0–24
Supply current (mA max.)	20	8 mA normal, 12 mA max.
Operating temperature range (°C)	–40 to +125 °C	–40 to +125 °C
Output saturation voltage (mV max.)	1000	n/s
Output current (mA max.)	20	25
Connector	Delphi Metri-Pack 150	Delphi Metri-Pack 150

SPEED AND DIRECTION SENSOR KIT

Hall-effect speed and direction sensors with two Hall cells, one that detects speed and, in combination with the second, detects the direction of movement. The modular design allows customers to select a sensor in various standard configurations, such as immersion depth and output interface.

Features

- Suitable for sensing ferromagnetic structures at speeds from near zero to 20 kHz
- Variable immersion depth (20 to 80 mm)
- Variable shaft diameter (12 to 20 mm)
- 2-wire, 3-wire, 4-wire interface
- Rotatable sensor head (variability of cable outlet)
- Flexible cable outlet (front or angled)
- Pre-assembled versions (cable with connector) available
- Open collector, PWM, or current interface
- IP67
- RoHS compliant
- These sensors require the use of an external pull-up resistor, the value of which depends on the supply voltage.

Typical applications

- Electric drives (stationary and mobile)
- Automation systems
- Conveyors
- Wind turbines

SD74

Modular speed and direction sensor in a plastic housing

- Versions available in the following lengths: 20 mm, 35 mm, 45 mm, and 60 mm
- Connection via cable
- Cable outlet angled 90°
- Furnished with round flange mount



Technical data

Series	SD74 / SD84
Dimensions L/W/H mm (inches)	20.00–60.00 x 13.00 dia. (0.787–2.362 x 0.512 dia.)
Operating voltage range (V DC)	4.5–24
Supply current (mA max.)	13
Operating temperature range (°C)	–40 to +140 °C
Output current (mA max.)	25
Reverse battery protected	max. –18 V (supply line); max. –0.5 V (output signals)
Maximum input voltage	up to max. 28 V

SD84

Modular speed and direction sensor in a plastic housing with pre-assembled connector

- Versions available in the following lengths: 20 mm, 35 mm, 45 mm, and 60 mm
- Connection via pre-assembled TYCO AMP Superseal connector (other connection systems available on request)
- Cable outlet angled 90°
- Furnished with round flange mount

SDB4

Modular speed and direction sensor in a plastic housing with pre-assembled connector and straight cable outlet

- Versions available in the following lengths: 20 mm, 35 mm, 45 mm, and 60 mm
- Connection via pre-assembled TYCO AMP Superseal connector (other connection systems available on request)
- Cable outlet straight
- Furnished with round flange mount



Technical data

Series	SDB4
Dimensions L/W/H mm (inches)	20.00 – 60.00 x 13.00 dia. (0.787 – 2.362 x 0.512 dia.)
Operating voltage range (V DC)	4.5 – 24
Supply current (mA max.)	13
Operating temperature range (°C)	– 40 to + 140 °C
Output current (mA max.)	25
Reverse battery protected	max. – 18 V (supply line); max. – 0.5 V (output signals)
Maximum input voltage	up to max. 28 V

ANGLE POSITION SENSORS

Angle position sensors based on Hall technology respond to magnetic fields generated by a (rare-earth) magnet. They provide a linear change in voltage output corresponding to the rotation of the axis.

Features

- High tolerance for misalignment
- Available with different connector and connecting cable versions
- IP67
- RoHS compliant

Typical applications

- Hydraulic valve
- Hydraulic controls
- Electric drives
- Pneumatic controls
- Zero-contact encoder alternative
- Gear selection/shifting position
- Lifting and driving height position
- Throttle valve and pedal switch
- Steering wheel position

AN1

Angle position sensor with integrated magnets and return spring

- Patented intrinsically linear angle position sensor (ILAPS)
- Magnet/sensor orientation provides linear output from 5° to 85° of rotation without the need for electrical compensation
- Return spring provides resistance to CCW motion
- Fully encapsulated assembly

AN8

Programmable angle position sensor for 360° applications

- Non-contact angular position sensing for 360° rotation
- Custom programming available for: angle range, offset, PWM output, custom magnets – contact factory
- Separation of sensor and magnet means no mechanical wear
- Available with Delphi connector or 305 mm wire leads



Technical data

Series	AN1	AN8
Dimensions L/W/H mm (inches)	47.10 x 51.10 x 23.50 (1.850 x 2.010 x 0.930)	48.30 x 57.33 x 17.70 (1.900 x 2.260 x 0.700)
Rotational sensing range	5 to 85°	0 to 360°
Supply voltage (V DC)	5.0 ±10%	5.0 ±10%
Resolution	analog	analog
Operating temperature range (°C)	-40 to +125 °C	min. -40 to +125 °C

AN9

Programmable angle position sensor for 360° rotation

- Non-contact angular position sensing for 360° rotation
- Two separate output signals for extreme reliability
- Custom programming available for: angle range, offset, PMW output, custom magnets – contact factory
- Separation of sensor and magnet means no mechanical wear
- With 305 mm wire leads

ANG

Programmable angle position sensor for 360° rotation

- Custom programming available for: angle range, slope, PMW output, custom magnets – contact factory
- No mechanical interface means no parts to wear out or jam
- Available with 20 AWG 305 mm (12") discrete wire leads
- IP68
- Maximum airgap of 6 mm (0.24")
- EMC/EMI/ESD compliant in accordance with industrial/automotive guidelines



Technical data

Series	AN9	ANG
Dimensions L/W/H mm (inches)	48.30 x 40.00 x 8.50 (1.900 x 1.570 x 0.335)	32.50 x 42.95 x 6.50 (1.280 x 0.250 x 0.425)
Rotational sensing range	0 to 360°	0 to 360°
Supply voltage (V DC)	5.0 ±10%	5.0 ±10%
Resolution	analog	12 bit
Operating temperature range (°C)	-40 to +125 °C	-40 to +140 °C

LINEAR POSITION SENSORS

Non-contact linear position sensors are equipped with one or two independent outputs. They provide a linear change in voltage output (ratiometric to the input voltage) corresponding to a linear displacement of the actuator magnet. The actuator magnet included in the set is specifically adapted and calibrated to the sensor.

Features

- Easy setup and robust monitoring with M4 screws
- Dual independent (redundant) outputs assure high reliability
- Custom programming available on request for: measuring range, slope, PWM output
- No mechanical interface means no parts to wear out or jam
- Available with 20 AWG 305 mm (12") discrete wire leads or harness with connector
- RoHS compliant
- IP68
- Suitable for wide airgap applications
- EMC/EMI/ESD compliant in accordance with industrial/automotive guidelines

Typical applications

- Hydraulic valves
- Hydraulic controls
- Electric drives
- Pneumatic controls
- Zero-contact encoder alternative
- Gear selection/ shifting position
- Lifting and driving height position
- Throttle valve and pedal switch
- Steering wheel position



Technical data

Series	LIN
Dimensions L/W/H mm (inches)	32.50 x 42.95 x 6.50 (1.280 x 0.250 x 0.425)
Measuring range	up to 45 mm
Supply voltage (V DC)	5.0 ± 10 %
Resolution	12 Bit
Operating temperature range (°C)	-40 to +140 °C
Output signal (V DC)	0.5-4,5
Reverse battery protected	up to 12 V DC

DIGITAL VANE SENSORS

A Hall-effect digital vane sensor with a permanent magnet in two forks, separated by a 3.4 mm (0.135") airgap. The output switches when a ferrous target passes between the forks. Typical targets are rotary vanes, saw teeth moving in a linear direction, and openings in a metal band.

Features

- Mechanically interchangeable with optical switches
- Robust sensing even in dusty environments
- No mechanical wear
- Open collector (sinking or NPN) output can be used with bipolar or CMOS logic circuits with suitable pull-up resistor
- Reliable and repeatable
- Immune to moisture and dust
- Recommended vane parameter materials:
iron, steel
Min. dimensions: 1.00 mm thick, 6.35 mm wide
The vane should penetrate a depth of less than 3 millimeters from the bottom of the sensor slot
- Housing constructed of fiberglass reinforced polyester
- RoHS compliant
- These sensors require the use of an external pull-up resistor, the value of which depends on the supply voltage.

Typical applications

- Door/gate position control
- Exercise equipment
- Printers

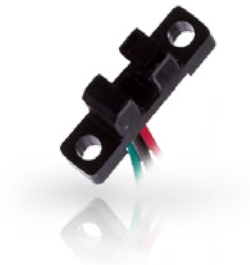

Technical data

Series	VN1015
Dimensions L/W/H mm (inches)	24.77 x 6.35 x 10.80 (0.975 x 0.250 x 0.425)
Operating voltage range (V DC)	3.8 – 24
Supply current (mA max.)	7.5
Operating temperature range (°C)	–40 to +85 °C
Output current (mA max.)	25
Reverse battery protected	up to –24 V DC

COMPENDIUM

General

Switching distance

The switching distance between a sensor and a magnet or any other target to be detected depends on:

- Sensing characteristics of the sensor
- Magnet material
- Magnet dimensions
- Relative motion of the magnet with respect to the sensor
- Presence of nearby magnetic or ferrous materials

ESD sensitivity

- Reed sensors are not solid-state devices and thus immune to ESD
- Several of our Hall sensors – including GS1001-1004, GS1012, and SD1012 – are equipped with additional circuitry to enhance ESD immunity. They have been tested for ESD immunity in accordance with IEC publication 1000-4-2 using testing standard EN50082-2. Sensors without this additional circuitry should be handled like other ESD-sensitive devices.

Connection / interfaces

Depending on the type and version, the sensors are equipped either with a defined standard connector or with wire leads for individual connection.

Housing

ZF sensors are delivered in ready-for-assembly housings for the indicated protection class.

Vane sensors

(VN sensors on page 17)

These sensors are actuated by a vane passing through the fork. The ferromagnetic vane changes the magnetic field between the sensor and the magnet in the two arms of the fork.

Vane material

In general, all ferromagnetic materials are suitable for vanes. We recommend iron or steel.

Vane dimensions

We recommend a vane material thickness of at least 1 millimeter and an individual vane width of at least 6.35 millimeters. The vanes should penetrate a depth of less than 3 millimeters from the bottom of the sensor slot.

Magnetic proximity sensors

(MP sensors on pages 4 to 7)

Magnetic proximity sensors are used for the non-contact – and thus wear-free – sensing of position and movement. ZF offers standard product solutions based on Hall and Reed technology.

Hall or Reed?

Although both types of sensor detect the proximity of magnets, Hall and Reed sensors differ greatly in the way they function. Hall sensors are solid-state devices whose output changes when exposed to a magnetic field. Reed sensors, on the other hand, are electrically switched with two tiny contacts in a vacuum tube that open or close in the absence or presence of a magnetic field.

Both sensor technologies have their specific advantages, depending on the application:

Hall sensors have a virtually unlimited life, making them suitable, for example, for sensing a rotating magnet that passes the sensor millions of times. Reed sensors also have a very long life compared to other electromechanical solutions, but they can't match the extremely long life of a solid-state Hall sensor. Hall sensors are ideal for sensing gear teeth or speed, whereas Reed sensors are limited to bipolar position sensing.

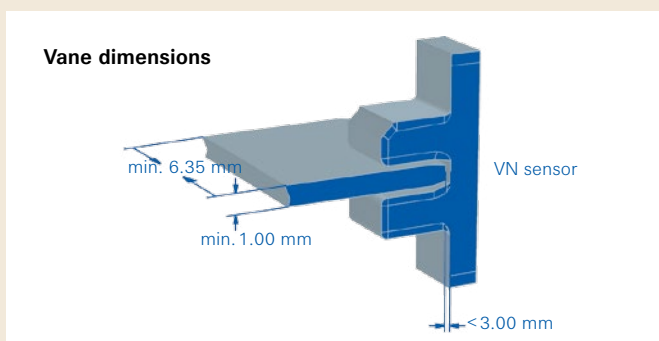

COMPENDIUM

The advantage of Reed sensors is that they consume zero power in standby mode, making them extremely energy efficient. In addition, they are immune to ESD and serve as a low-cost alternative to Hall technology, which requires ESD protection. Another use for Reed technology is in applications with supply voltages outside the typical 5 to 24 V DC range typical of Hall sensors. Reed sensors can effectively switch 110 V DC at low current.

Reed sensors

Reed sensors are available in different contact configurations:

Normally open (Form A):

Near a magnetic field, this sensor closes.

Normally closed (Form B):

Near a magnetic field, this sensor opens.

Changeover (Form C):

In the rest position, the circuit between the COM and NC contact is closed. When exposed to a magnetic field, the circuit between the COM and NC contact opens and the circuit between the COM and NO contact closes.

Magnetic poles

Most of ZF's standard Hall-based sensors are south pole-sensitive. Exceptions include the MP101303 and MP101304 sensors, which are latched with a south pole and unlatched with a north pole. The MP1021 series includes both unipolar, north pole-sensitive devices and bipolar devices that are unlatched with a north pole and latched with a south pole. All of ZF's Reed sensors (MP2007 through MP2019) are omnipolar.

Airgap (distance between sensor and magnet)

The field strength at various points around a permanent magnet is dependent on several factors, including the shape, size, and material of the magnet. Most standard ZF sensors exhibit a similar sensitivity, with some exceptions. Our MP101303 and MP102104 bipolar sensors have relatively low gauss thresholds, allowing for somewhat wider airgaps.

Switching hysteresis

The switching hysteresis is determined by the difference between the activation point as the magnet moves toward the sensor and the deactivation point as the magnet moves away from the sensor.

Sensor operation

A Reed Sensor is an omnipolar, magnetically activated switch. It can be approached by a magnet from any angle and with either pole. Several possible operating methods are shown below.

Perpendicular magnet travel

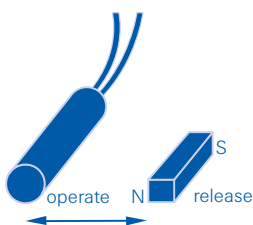

This method maximizes the airgap

Parallel magnet travel

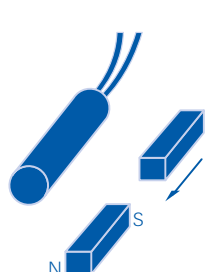

Up to three operations possible with one magnet

Nose-to-nose activation

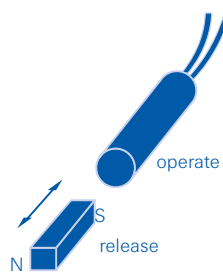

Both ends of the magnet work equally well

Rotational magnet travel

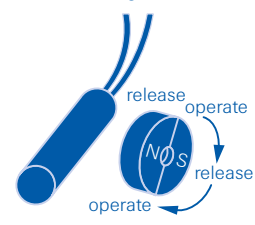

Multi-pole ring magnets can be used to achieve a larger number of operations per rotation

COMPENDIUM

Gear tooth sensors

The gear tooth sensor category includes both speed sensors and combination speed and direction sensors.

Speed and direction measurement

Sensors in the SD series provide both speed and direction information. SD series sensors incorporate two Hall-effect ICs that are slightly offset from one other. The resulting minimum phase distance between the two signals is analyzed by means of internal conditioning logic and the direction of the target rotation is determined. The information is output via two digital outputs. These outputs use an open collector (sinking) output. The speed signal switches from high (Vcc) to low (near zero) when it detects a transition from “no-tooth” to “tooth present”.

The direction signal, which is output at a separate pin, is high when gear rotation is clockwise and low when gear rotation is counter-clockwise.

Operating a speed sensor

Although commonly known as gear tooth sensors, solid-state speed sensors not only sense the speed of gear-teeth but are also suitable for detecting the rotations and motion of various targets with some type of discontinuous surface, provided that they are magnetically conductive. Examples of appropriate targets include:

- Sprockets
- Bolt head
- Roller chains
- Cavities in smooth surfaces

Ferromagnetic materials are most suitable as targets to be measured. We recommend iron or steel.

Other factors that influence sensor performance include target shape, gear tooth height, and the distance between teeth.

Orientation

GS series sensors are not orientation-sensitive. SD series speed and direction sensors do have an orientation requirement, and the appropriate orientation is noted on the housing.

Tooth height	Tooth width	Distance between teeth	Target thickness
5 mm (0.200")	2.5 mm (0.100")	10 mm (0.400")	6.25 mm (0.250")

Airgap (distance between sensor and target)

The required distance between sensor and target depends on the installation situation. In general, smaller targets require smaller airgaps than targets with a larger diameter. Often the value actually required can be determined only after the sensor is installed. Consider starting with an airgap of 1 to 2 millimeters (0.04" to 0.08").

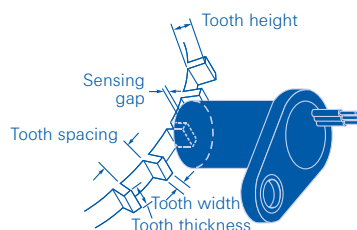

Proximity sensor with ring magnet

ZF's solid-state proximity sensors also make excellent speed sensors when coupled with a rotating ring magnet. Advantages of this approach include lower sensor costs, larger airgaps, and absolute zero-speed sensing.

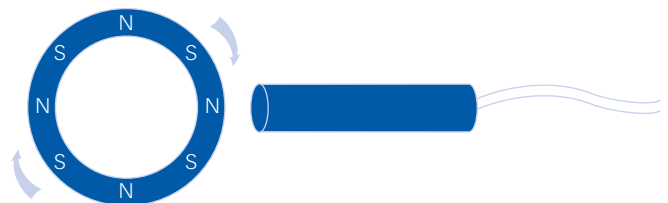

COMPENDIUM

Operating life

As a solid-state device with no moving parts, the operating life a ZF speed sensor is virtually unlimited.

Frequency

The measuring range depends on the sensor type and the target, but maximum frequency is generally > 10 kHz. The target geometry must be noted when calculating the frequency. With asymmetrical targets, for example, with narrow tooth widths as compared to the distances between teeth, the time between the leading and trailing edge of the tooth is the governing factor. ZF sensors have maximum response times from approximately 10 µS (MP series) to around 50 µS (GS series), due to the response time of the Hall cell. If the required response time is very close to these limits, it can lead to unexpected results, such as lost counts.

Unlike passive speed sensors (VR or variable reluctance sensors), a GS sensor has an output amplitude that is independent of input frequency (speed). This means that the sensor does not require a minimum speed. However, it does require some initial movement of the target in order to locate the tooth edge. We therefore prefer to call it a “near-zero-speed” sensor.

Current sink interfacing

3-wire interface

Sinking outputs are often used in negative logic applications, where a low signal is required for an active state. There, sinking outputs normally have current flowing into the device output lead when the device is active. Also called “open collector outputs”, sinking outputs are compatible with any logic family because they can be used for a wide range of supply and output voltages. Furthermore, the supply voltage used to power the Hall assembly may differ from the pull-up voltage to which it is connected.

The external pull-up resistor connected between the output and supply voltage is required for proper operation.

With the resistor connected as shown, the output will be “pulled up” to the supply voltage (Vcc) level when off and (approximately) to ground when on.

Recommended pull-up resistor values *					
Volts DC	5	9	12	15	24
Ohms	1k	1.8k	2.4k	3k	3k

* Precise values supplied on request.

Sensor series	Connector type	Connection grid				
		Vcc	Output	Ground	Direction	Speed
MP	12 mm Round	1	4	3	n/a	n/a
	Wire lead	Brown	Black	Blue	n/a	n/a
	Wire lead	Red	Green	Black	n/a	n/a
GS	12 mm Round	1	4	3	n/a	n/a
	Wire lead	Brown	Black	Blue	n/a	n/a
	Delphi	A	B	C	n/a	n/a
VN	Pin	1	3	2	n/a	n/a
	Wire lead	Red	Green	Black	n/a	n/a
SD	Delphi	C	–	D	A	B
	Wire lead	Red	–	Black	White	Blue

ZF Friedrichshafen AG

Cherrystrasse
91275 Auerbach
Germany
Phone +49 9643 18-0
Fax +49 9643 18-1720
www.switches-sensors.zf.com

twitter.com/zf_konzern
facebook.com/zffriedrichshafen
youtube.com/zffriedrichshafenag

**ZF Electronic Systems Pleasant Prairie LLC**

11200 88th Avenue
Pleasant Prairie, Wisconsin
USA 53158
Phone +1 262 942 6500
Fax +1 262 942 6566

ZF Electronics Asia Limited

2 / F Technology Plaza
29-35 Sha Tsui Road
Tsuen Wan, New Territories
Hong Kong
Phone +852 25 65 66 78
Fax +852 25 65 68 27

ZF Electronics TVS (India) Private Limited

Madurai – Melur Road,
Vellaripatti, Madurai – 625 122
India
Phone +91 452 24 202 08
Fax +91 452 24 203 82

