

Sealed Subminiature Snap Switch



Single Pole DC Series

Features

- Precise snap action switch
- Long life coil spring mechanism
- Switching current 0.1 to 10 A at 250 VAC
- Versions up to 3 A 30 VDC possible
- Temperature range: -40 to 85 °C/120 °C
- Protection class: IP67 (switching system)
- Different mounting options (location posts, mounting holes)
- Various aux actuators (also for retrofitting)
- Various terminal types
- Wire versions available – protection class IP67

Standard Parts¹

DC1C-A1LB	DC1C-L1AA	DC1C-C4AA	DC1C-C3LC	DC1C-C3AA	DC1C-A1AA	DC2C-A1LB
DC2C-H1AA	DC2C-L1AA	DC2C-C3LD	DC2C-C3AA	DC2C-A1AA	DC2C-A1RC	DC2C-A1RB
DC2C-A1LC	DC3C-L1RC	DC3C-L1LB	DC3C-L1AA	DC3C-H1AA	DC3C-C3AA	DC3C-A1RC
DC3C-A1RB	DC3C-A1LC	DC3C-A1LB	DC3C-A1AA			

¹The part number configuration matrix below provides details to the part numbers above.

For configurable part numbers that are not listed above, not listed in your region, or for custom part numbers, contact the factory or your distributor: switches-sensors@zf.com

Order Code Matrix

Numbering Matrix Switch Series DC

D		C		2	C	-	C	3	L	C																										
Code	Electrical Rating according to IEC 61058-1		Code	Contact Configuration	Temperature Rating	Code	Terminal Type	Code	Terminal Configuration / Type of Mounting	Auxiliary Actuator																										
	1	6(2) A, 125/250 VAC		A			SPST-NO		40T105 / 40T120	A	Solder short	1	30° distorted	Length in mm		Auxiliary actuator version																				
				2			10(1.5) A, 125/250 VAC			B	SPST-NC			40T85	B	Lead 0.5 mm ²	B	4,8	7	42	without															
										C	SPDT				C	Lead 0.75 mm ²	C	2,5	4,7	39,7	with roller															
3	0.1 A, 125/250 VAC	E	SPST-NO	D	Lead 18 AWG	3	Lead inline with actuator	D	2,5	4,7	39,7	with simulated roller																								
4	3 A, 125/250 VAC	F	SPST-NC	E	Lead 16 AWG	4	Lead adverse to actuator	W	7	14		plastic straight																								
Standard Terminal Combinations											Special designs G: The last two digits are identified from AA, AB, etc. to ZZ.																									
A1, B3, B4, B5, D3, D4, D5, E3, E4, E5, H1, K6, K7, K8, K9 L1, M3, M4, M5, N3, N4, P3, P4, Q5, R1, S1, U3, U4, U5																																				
<table border="1"> <tr> <td>Code</td> <td>Terminal Type</td> </tr> <tr> <td>H</td> <td>PCB 1.3x0.5</td> </tr> <tr> <td>K</td> <td>PCB 0.6x0.5</td> </tr> <tr> <td>L</td> <td>Tab 2.8x0.5</td> </tr> <tr> <td>M</td> <td>Lead 20 AWG</td> </tr> <tr> <td>N</td> <td>Long base w/o lead solder terminal 30° twisted (form B)</td> </tr> <tr> <td>P</td> <td>Long base w/o lead solder terminal 30° twisted (form A)</td> </tr> <tr> <td>Q</td> <td>Long base w/o lead solder terminal 30° twisted (no operation)</td> </tr> <tr> <td>R</td> <td>PCB 0.8x0.5</td> </tr> <tr> <td>S</td> <td>Welding</td> </tr> <tr> <td>U</td> <td>Lead 22 AWG</td> </tr> <tr> <td colspan="2">Long base</td> </tr> <tr> <td colspan="2"> </td> </tr> </table>											Code	Terminal Type	H	PCB 1.3x0.5	K	PCB 0.6x0.5	L	Tab 2.8x0.5	M	Lead 20 AWG	N	Long base w/o lead solder terminal 30° twisted (form B)	P	Long base w/o lead solder terminal 30° twisted (form A)	Q	Long base w/o lead solder terminal 30° twisted (no operation)	R	PCB 0.8x0.5	S	Welding	U	Lead 22 AWG	Long base			
Code	Terminal Type																																			
H	PCB 1.3x0.5																																			
K	PCB 0.6x0.5																																			
L	Tab 2.8x0.5																																			
M	Lead 20 AWG																																			
N	Long base w/o lead solder terminal 30° twisted (form B)																																			
P	Long base w/o lead solder terminal 30° twisted (form A)																																			
Q	Long base w/o lead solder terminal 30° twisted (no operation)																																			
R	PCB 0.8x0.5																																			
S	Welding																																			
U	Lead 22 AWG																																			
Long base																																				
<table border="1"> <tr> <td>Code</td> <td>Terminal Configuration / Type of Mounting</td> </tr> <tr> <td>5</td> <td>Lead led out on the underside</td> </tr> <tr> <td>6</td> <td>w/o fixation pins right</td> </tr> <tr> <td>7</td> <td>w/o fixation pins left</td> </tr> <tr> <td>8</td> <td>with fixation pins right</td> </tr> <tr> <td>9</td> <td>with fixation pins left</td> </tr> <tr> <td>G</td> <td>Special designs</td> </tr> </table>											Code	Terminal Configuration / Type of Mounting	5	Lead led out on the underside	6	w/o fixation pins right	7	w/o fixation pins left	8	with fixation pins right	9	with fixation pins left	G	Special designs												
Code	Terminal Configuration / Type of Mounting																																			
5	Lead led out on the underside																																			
6	w/o fixation pins right																																			
7	w/o fixation pins left																																			
8	with fixation pins right																																			
9	with fixation pins left																																			
G	Special designs																																			



Electrical Specifications – Contact Ratings

Contact	EN61058	Electrical life	Ø of wire
DC1	6(2) A, 125/250 VAC	10,000	0.75 mm ²
DC2	10 (1.5) A, 125/250 VAC	10,000	0.75 mm ²
DC3	0.1 A, 125/250 VAC	100,000	0.50 mm ²
DC4	3 A, 125/250 VAC	50,000	0.50 mm ²

Contact	UL61058-1	Electrical life 40T85	Electrical life 40T105 / 40T120	Ø of wire
DC1	6(2) A, 125/250 VAC	10,000	10,000	0.75 mm ²
DC2	10 (1.5) A, 125/250 VAC	10,000		0.75 mm ²
DC3	0.1 A, 125/250 VAC	100,000	100,000	0.50 mm ²
DC4	3 A, 125/250 VAC	50,000	50,000	0.50 mm ²

Contact	UL 1054	Electrical life	Ø of wire
DC1	5 A, 125/250 VAC	6,000	AWG20
DC2	10.1 A, 125/250 VAC	6,000	-
DC3	0.1 A, 125/250 VAC	100,000	AWG22
DC4	3 A, 125/250 VAC	6,000	AWG22

UL file number E314201

Environmental and Mechanical Specifications

Operating force	200 – 340 cN (model dependent, without actuator)
Mechanical life	min. 1x10 ⁶ operations
Temperature range	-40 °C to 85 / 120 °C without wire leads -40 °C to 85 / 105 °C without wire leads
Protection class	IP67

Material Specifications

Cover	PBT (UL 94 V-0); PET (UL 94 V-0)
Actuator	POM (UL 94 HB) 85 °C, PBT (UL 94V-0) 120 °C
Base	PET (UL 94V-0)
Contacts	Ag, AgNi, AuAgPt (Crosspoint)
Terminals	CuZn (silver-plated)
Sealing Gasket	VMQ
Auxiliary Actuator	Stainless steel or plastic



Dimensions (mm) and terminal configurations

Terminals

Solder terminals short

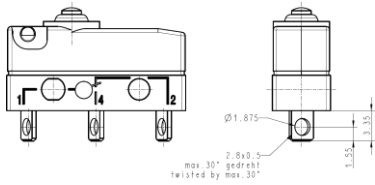

Q.C. terminals 2.8x0.5

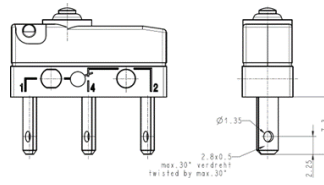

PCB terminals 1.3x0.5, straight

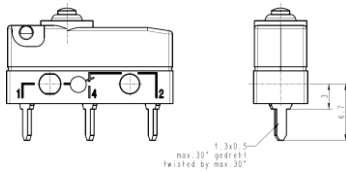

PCB terminals 0.6x0.5, straight

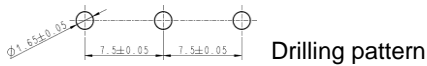
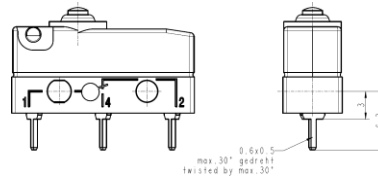

Drilling pattern



Drilling pattern

PCB terminals 0.6x0.5 RH-side without location posts

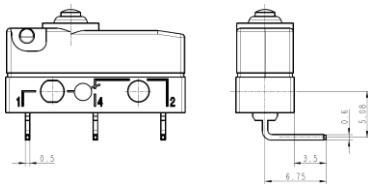

Drilling pattern

PCB terminals 0.6x0.5 LH-side without location posts

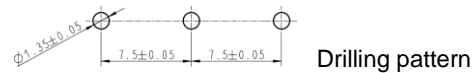
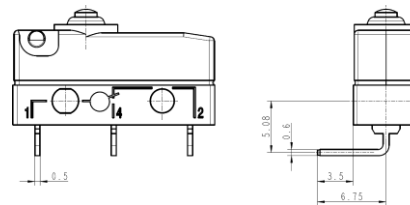

Drilling pattern

PCB terminals 0.6x0.5 RH-side with location posts

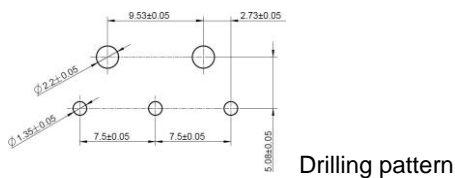
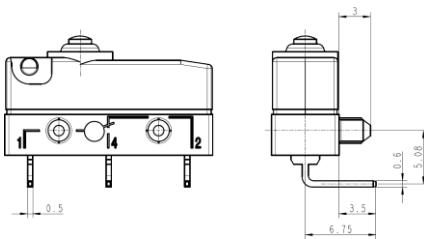

Drilling pattern

PCB terminals 0.6x0.5 LH-side with location posts

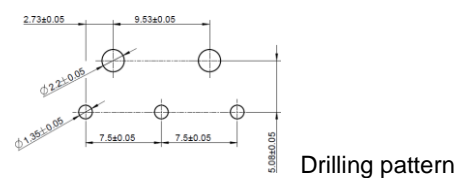
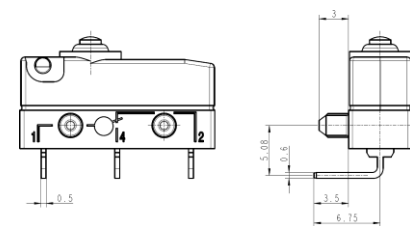

Drilling pattern

Auxiliary Actuators

Straight

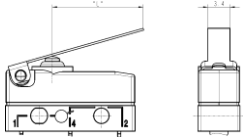

Simulated Roller

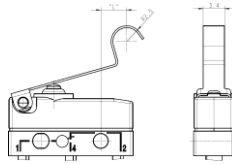

Roller

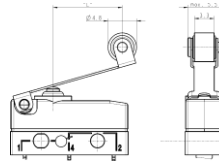

Dimensions

DC short

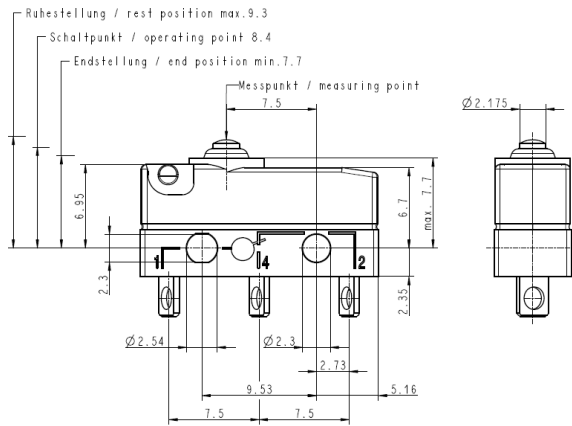

DC - long

